

6

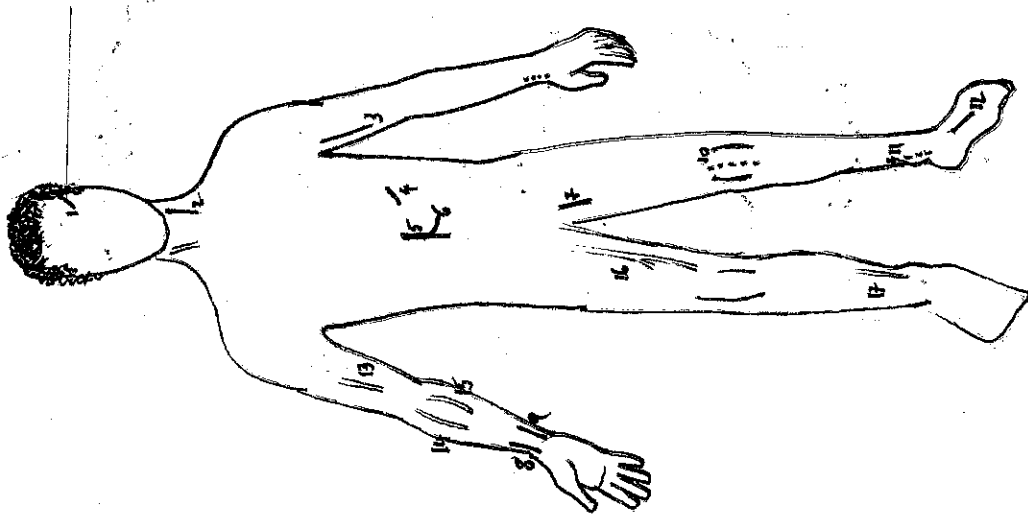

Página 7 (del Manual impreso)  
 1.2.1.6. Sistema vascular periférico

7

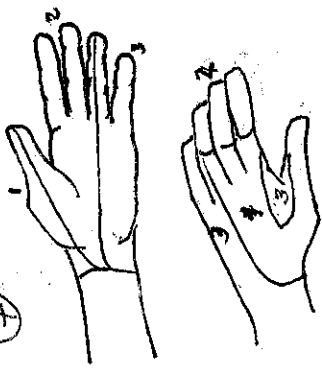

8

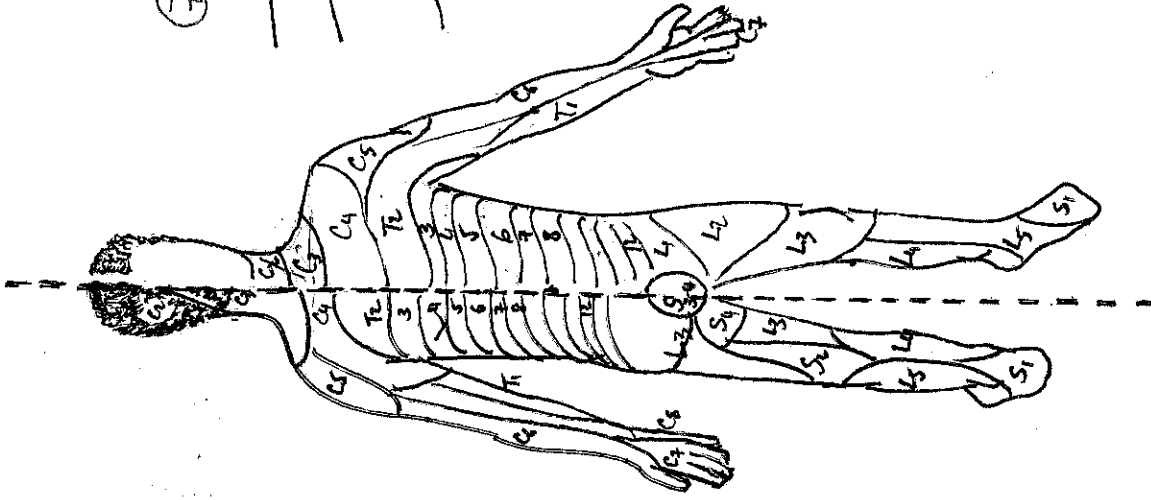
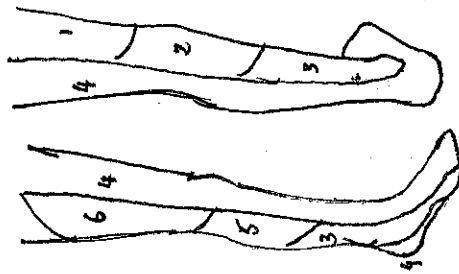

Página 12  
 1.2.1.11. Sistema Nervioso

1

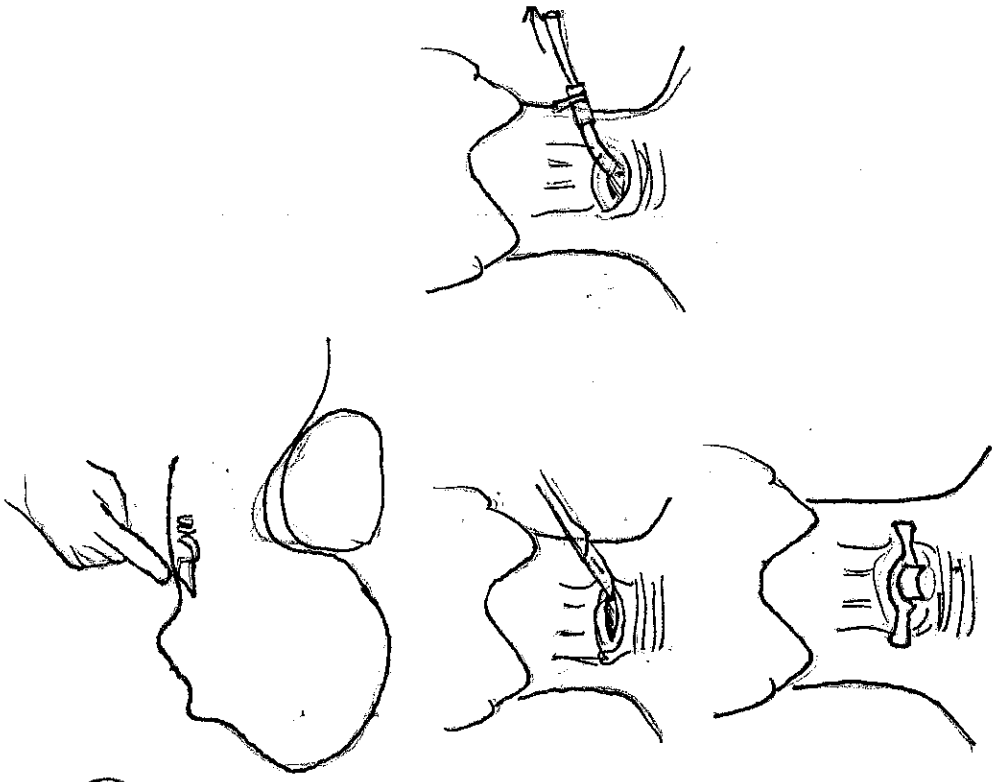
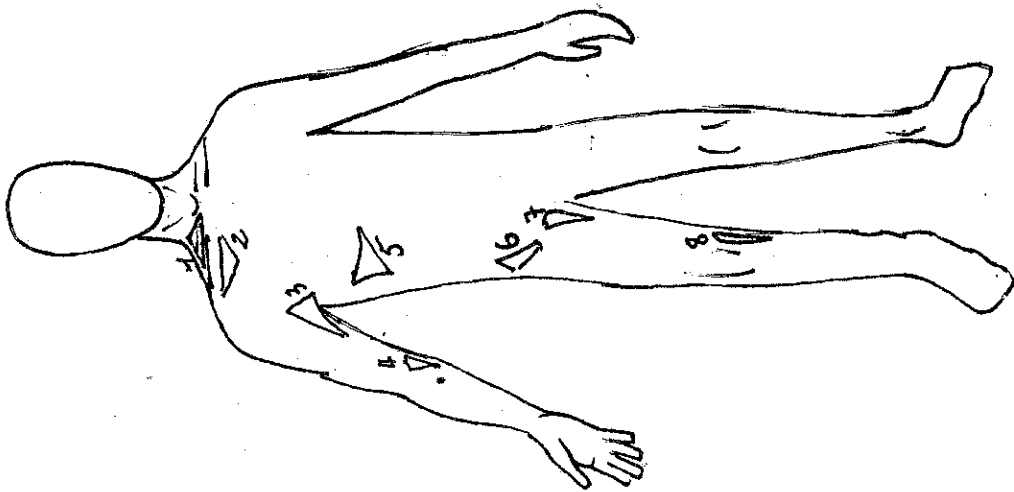
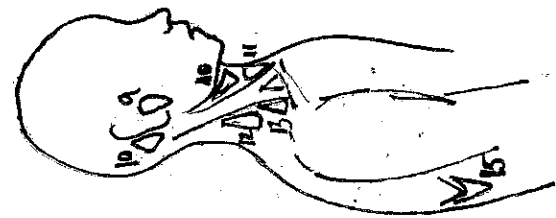

18.

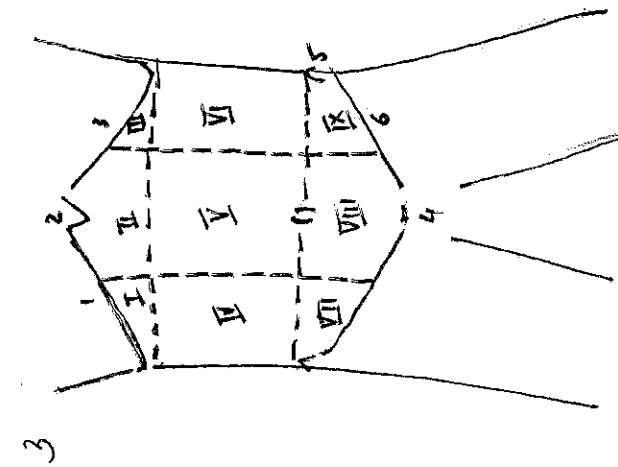
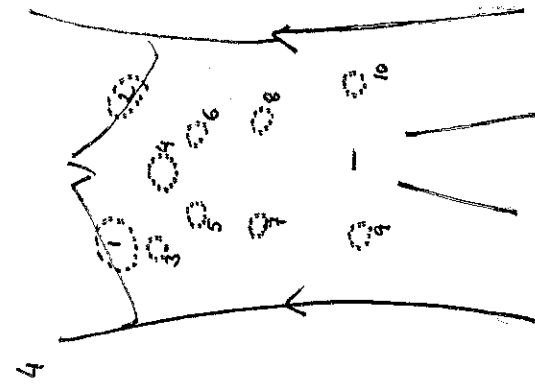
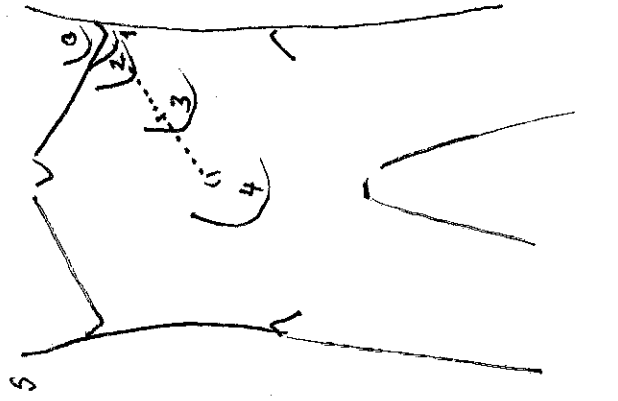
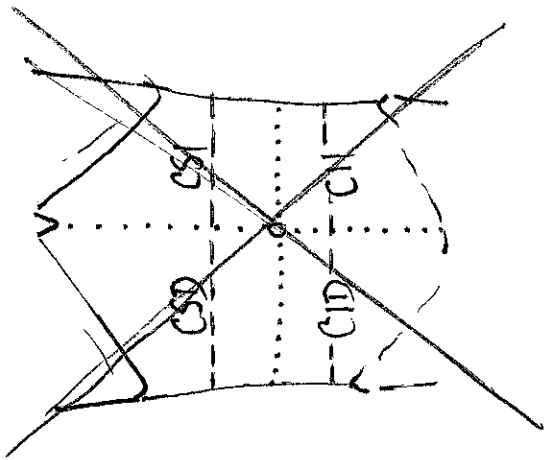

Pag. 8

1.2.1.10 Exploración abdominal  
 Ilustración 3. Soplos abdominales

Pag. 9

Ilustración 5

Pag. 9

Ilustración 4

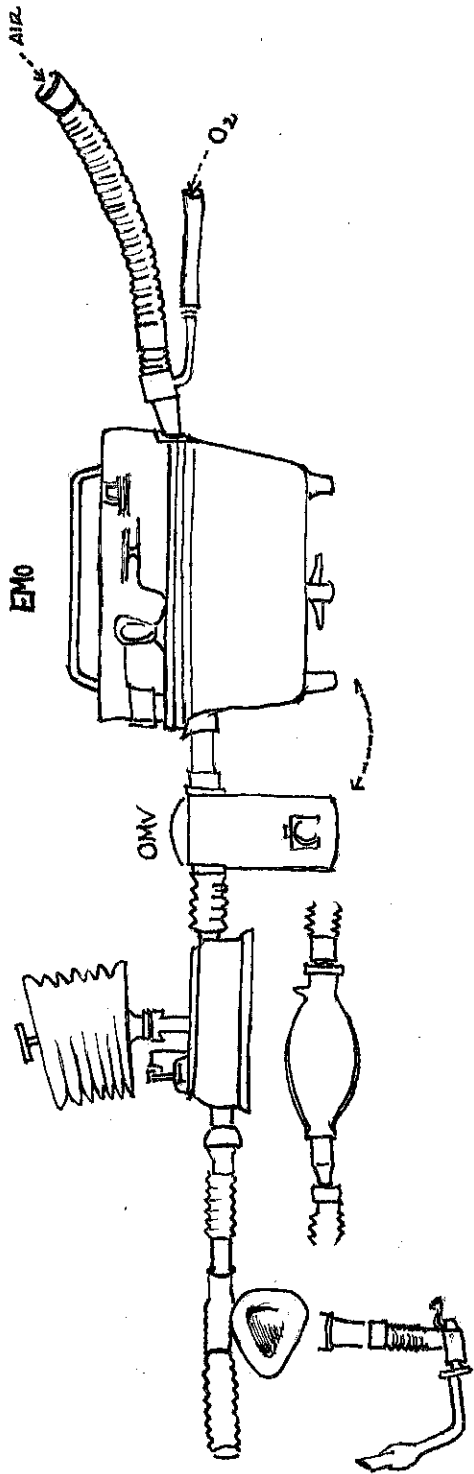

Página 24  
2.1.1 El vaporizador de éter.

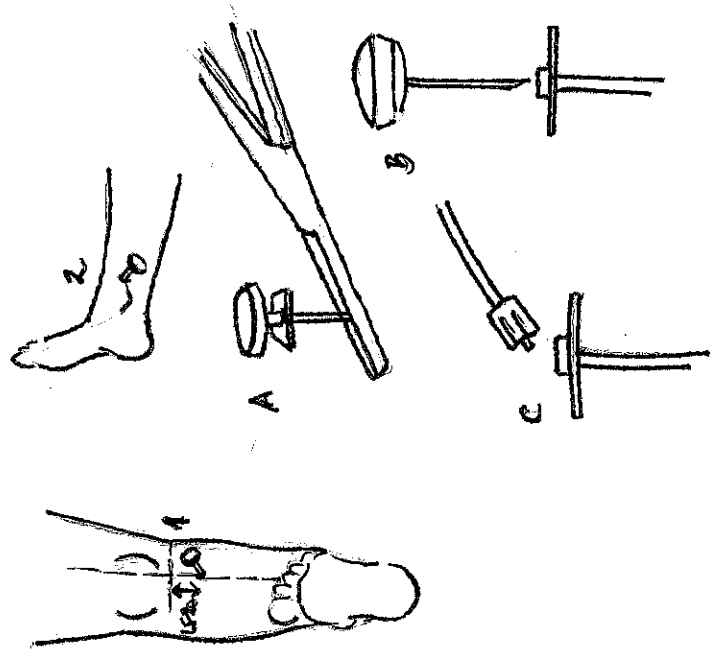
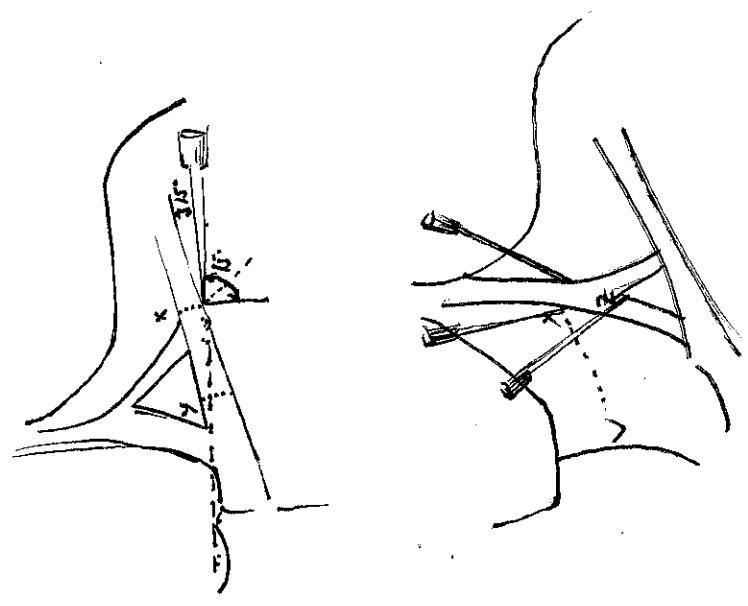
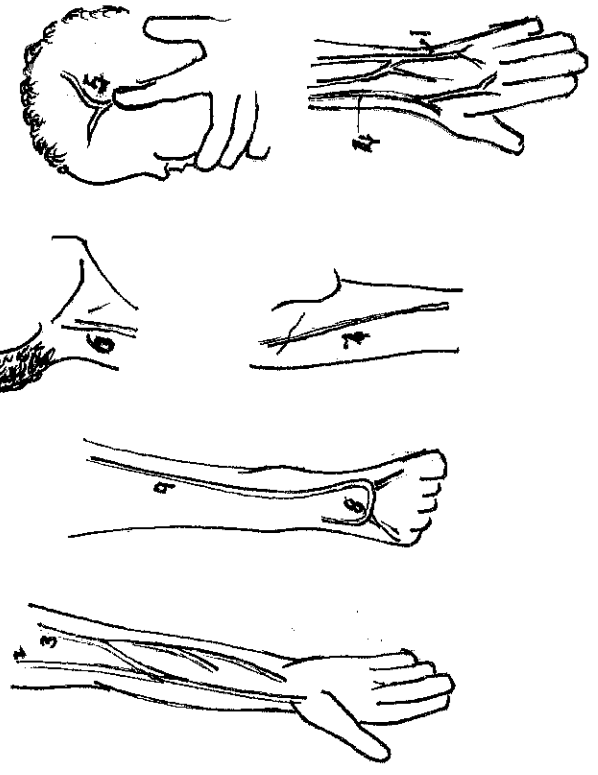

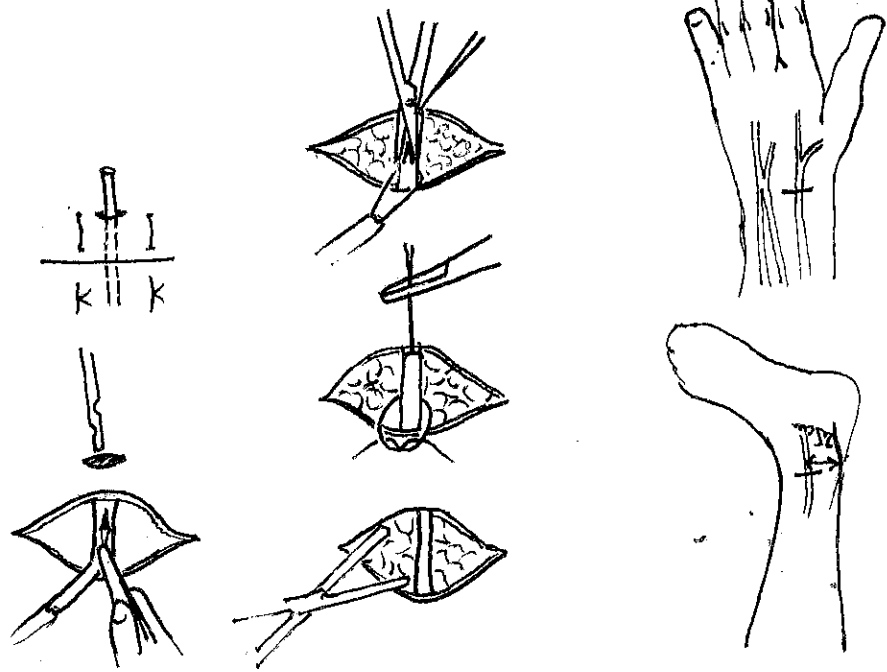

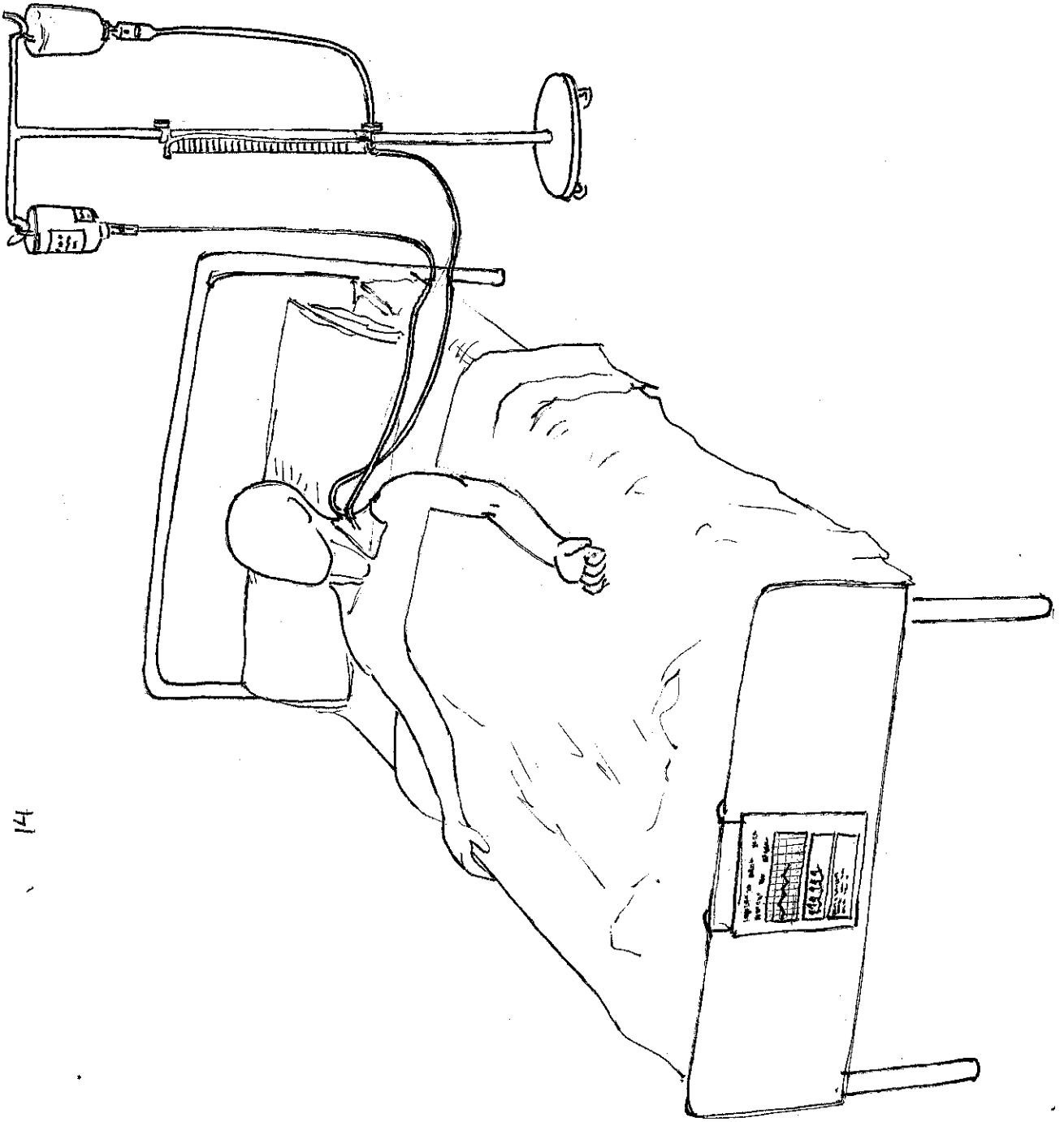

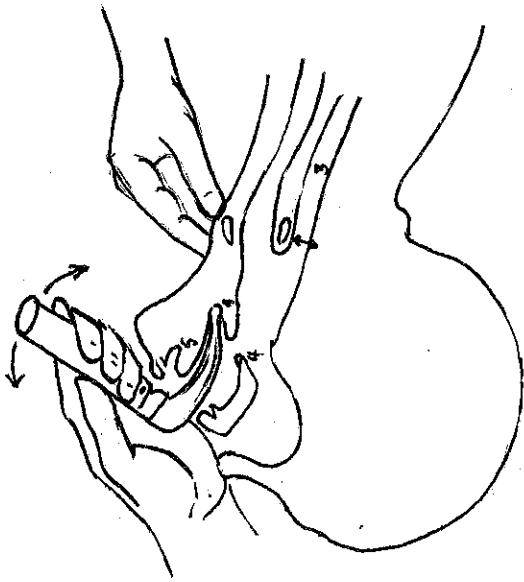

15

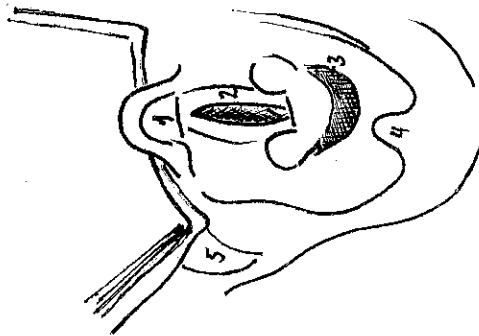

16



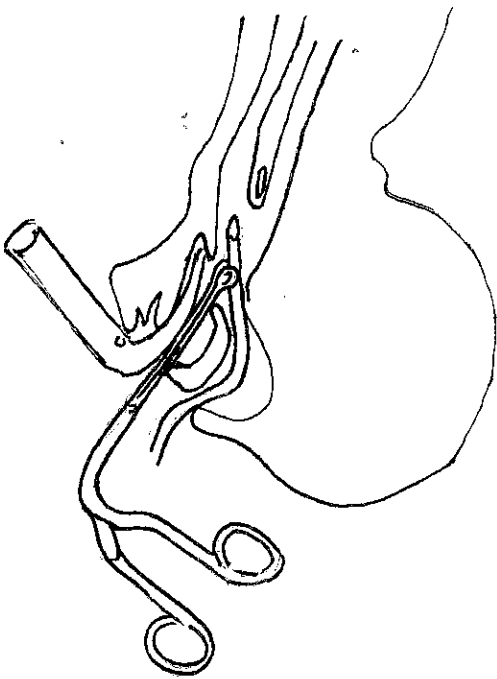

19

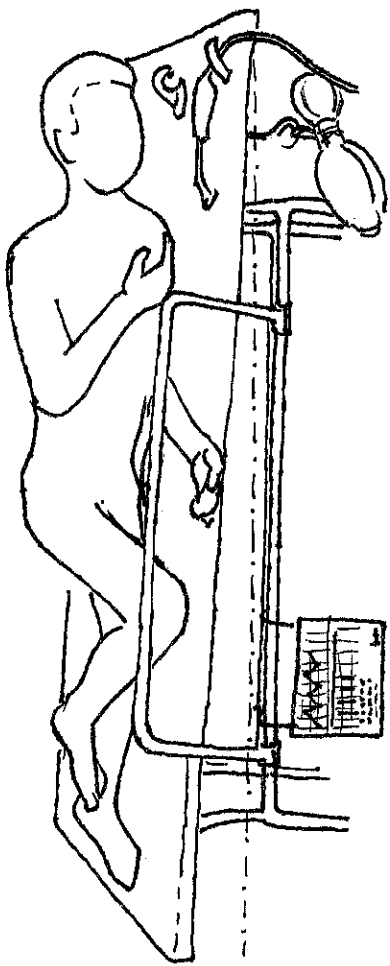

20

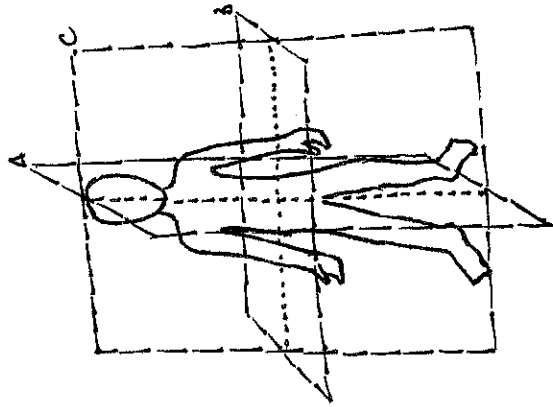

30

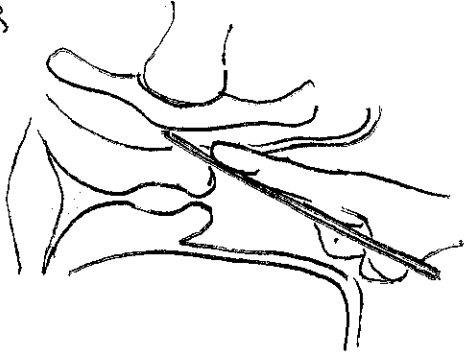

31

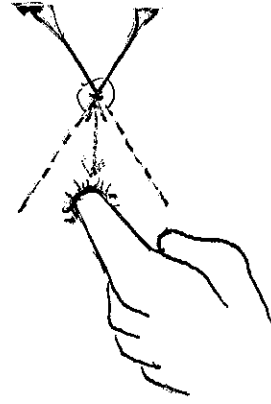

29

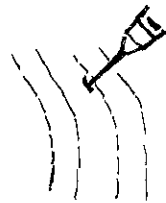

31

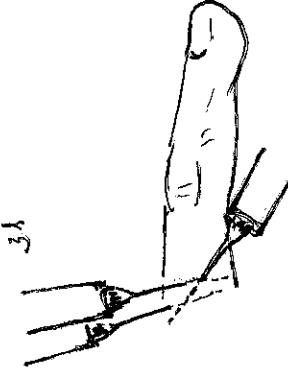

24

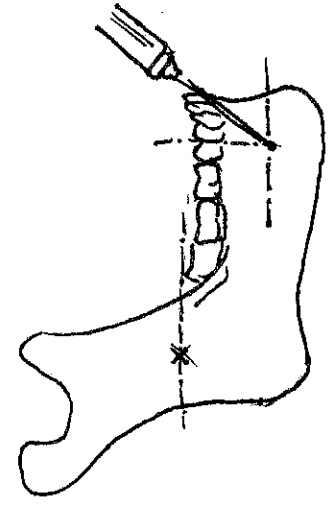

22

22

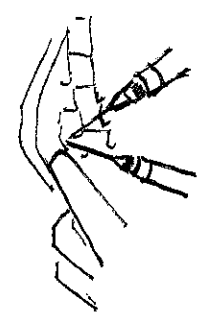

23A

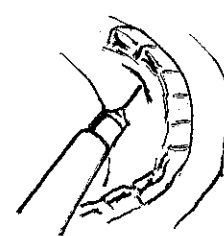

23B

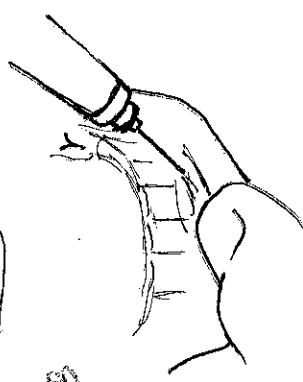

28

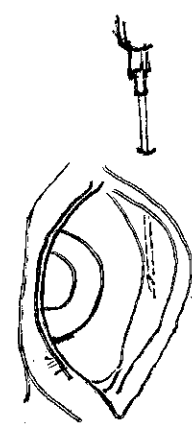

12

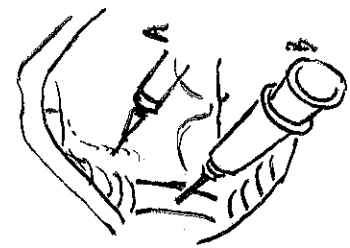

15

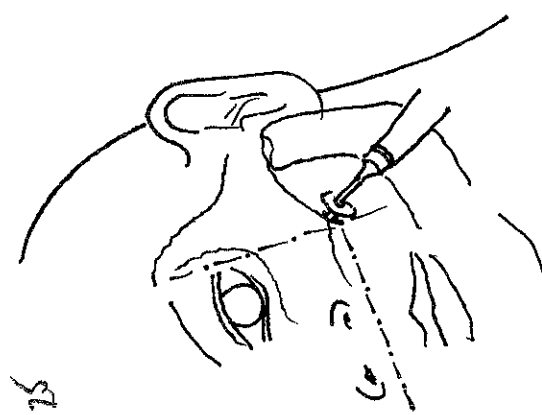

26

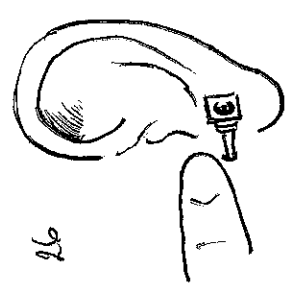

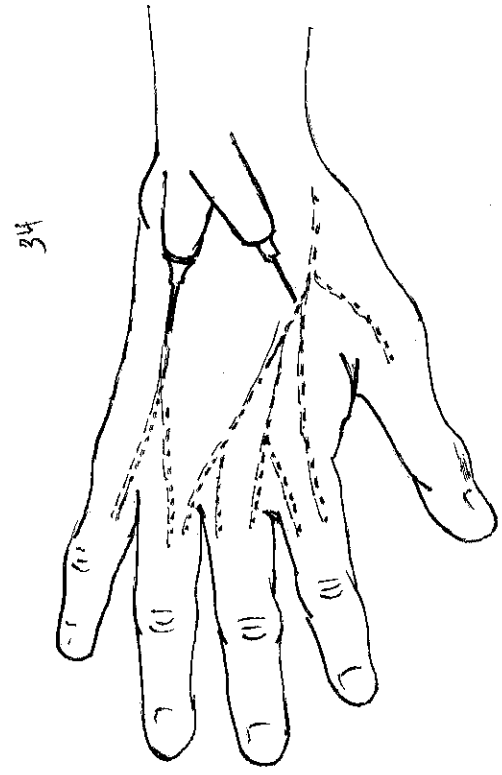
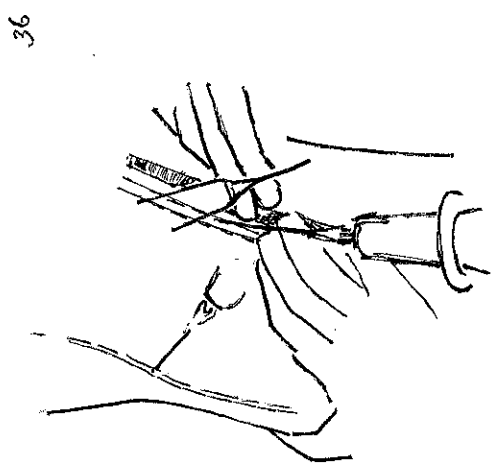
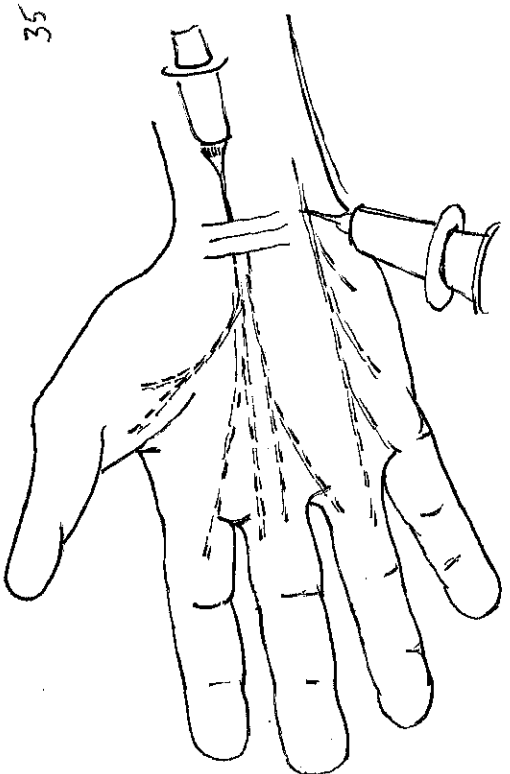

42

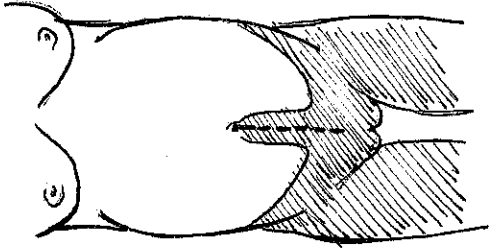

40

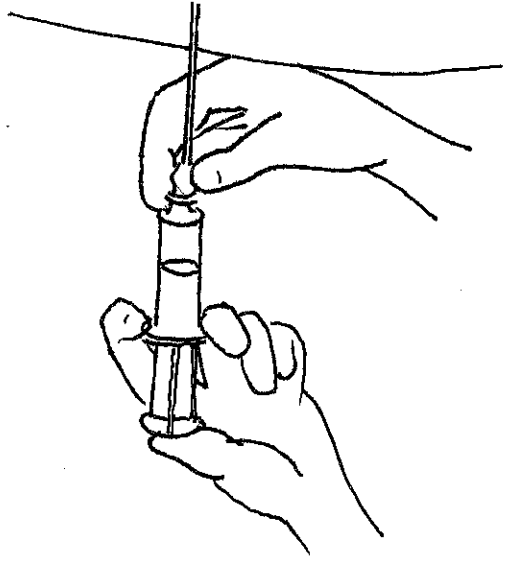

41

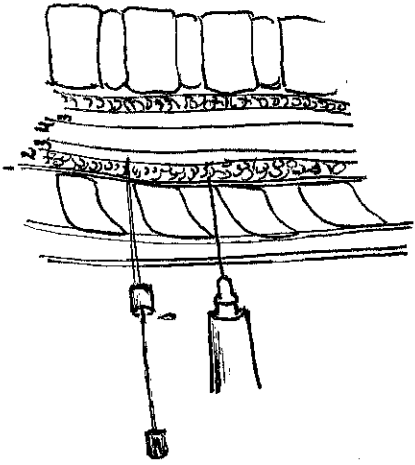

39



42

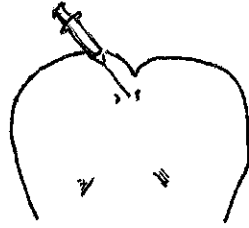

37

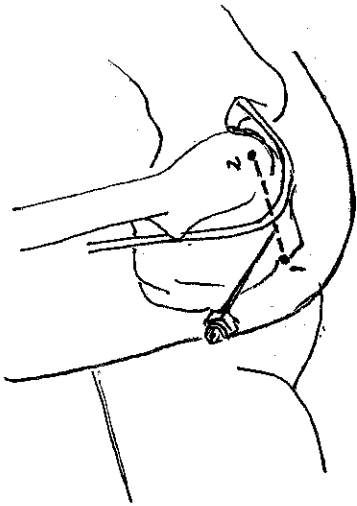

36

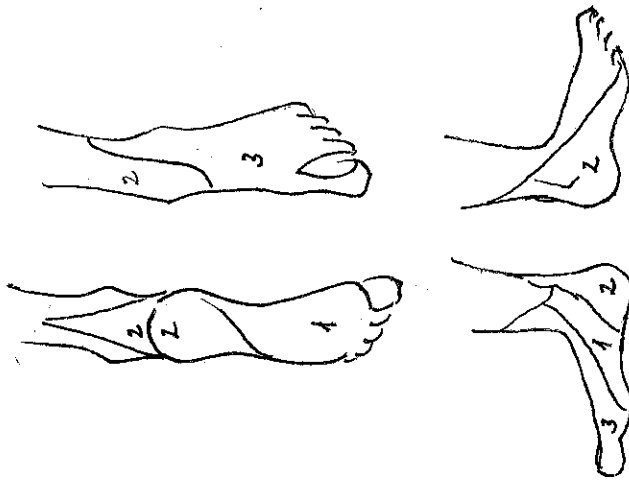

48

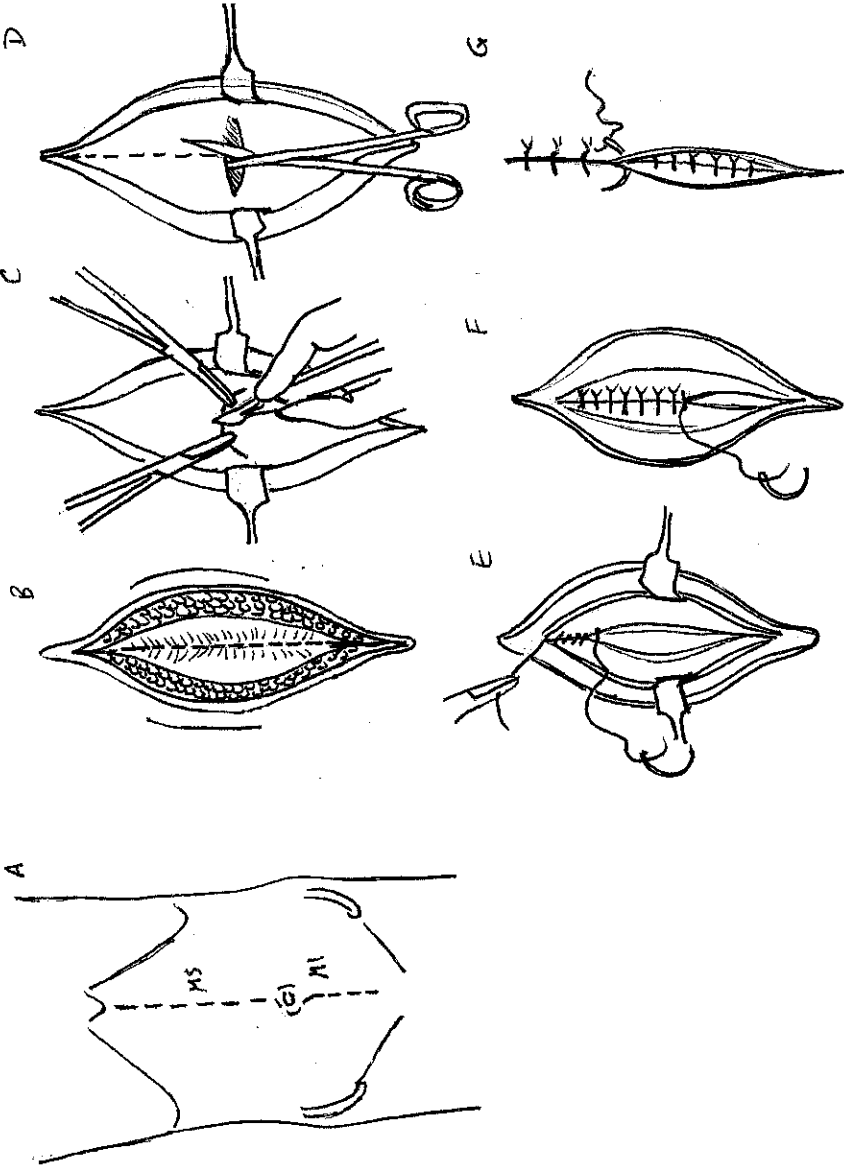

44

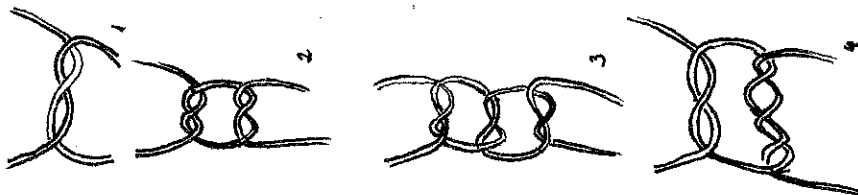

45



49

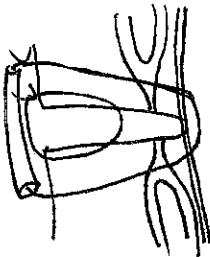

50

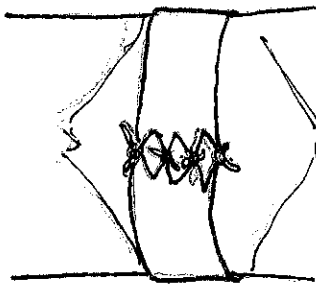

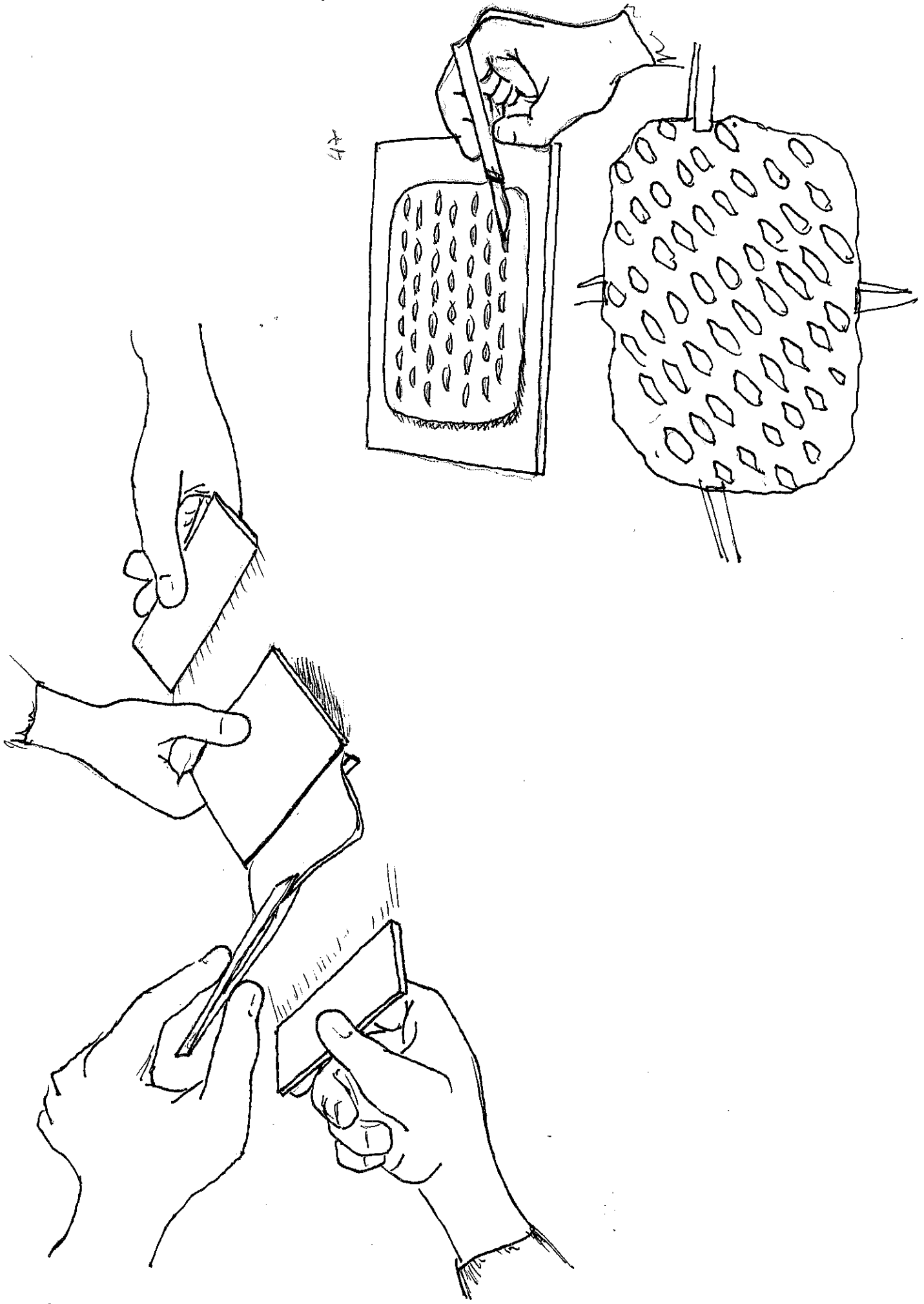

47

46

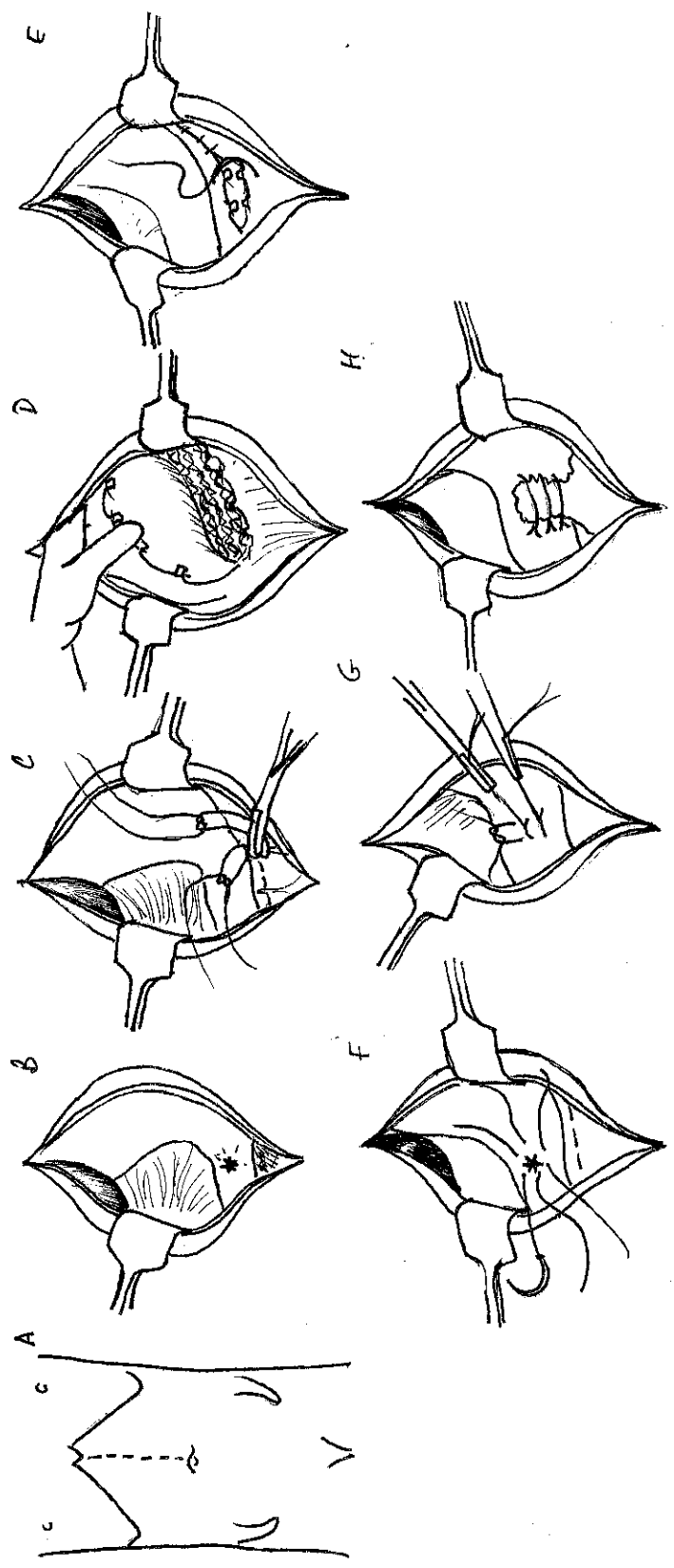



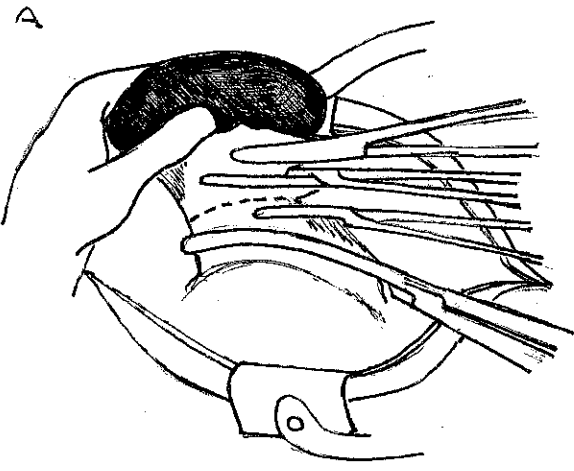

12

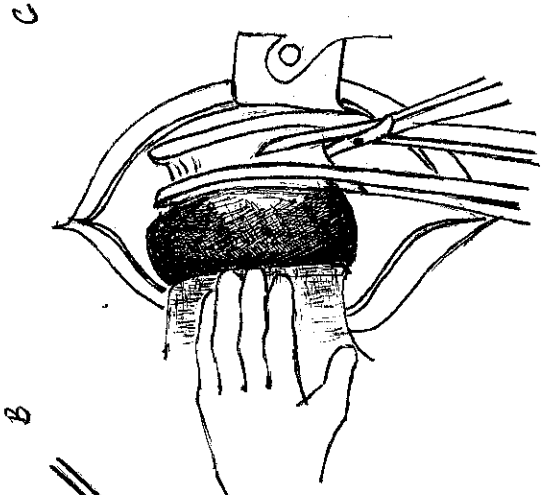
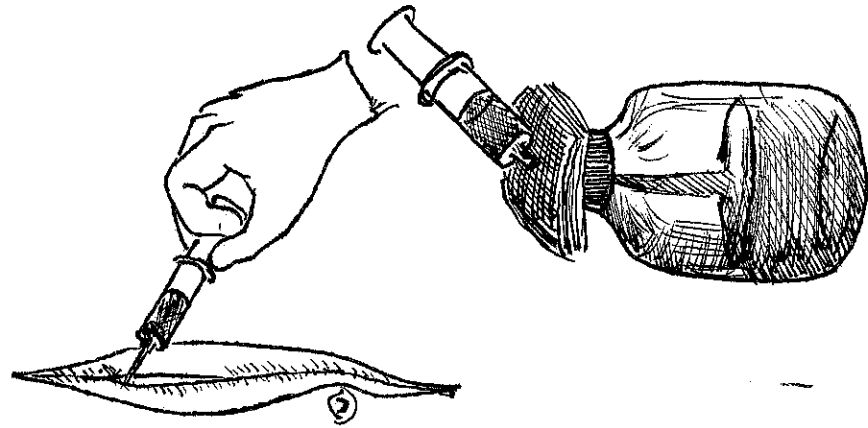

E

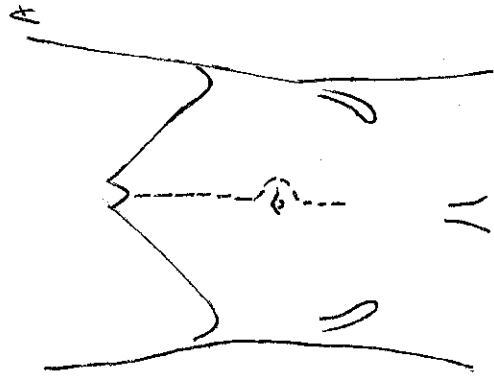
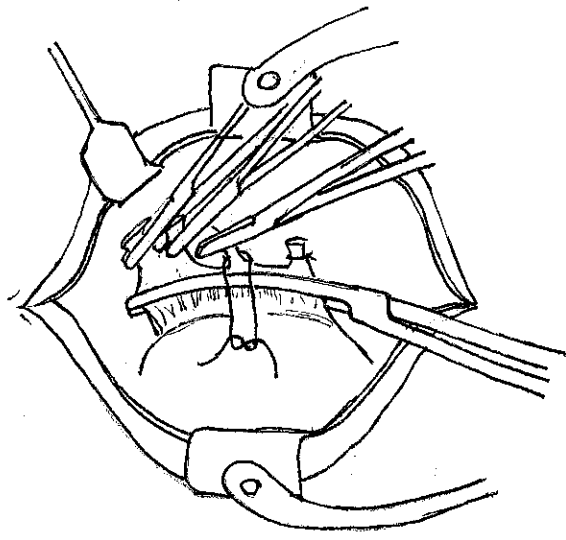

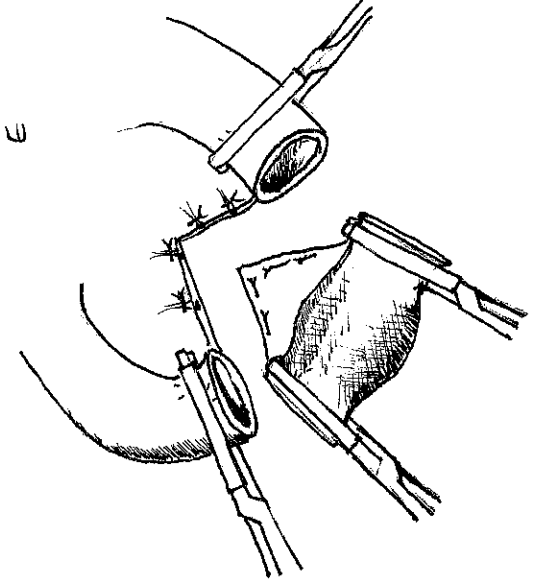
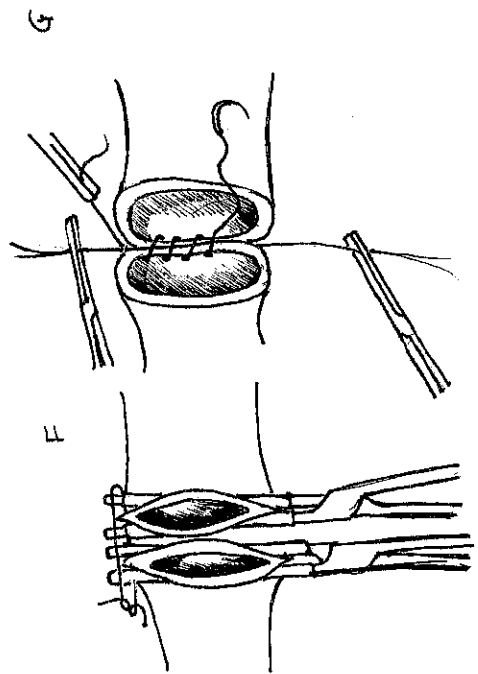
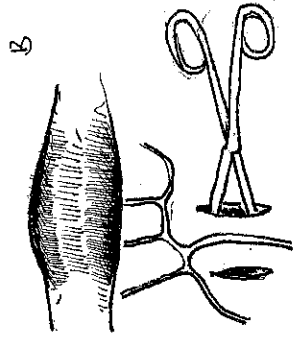
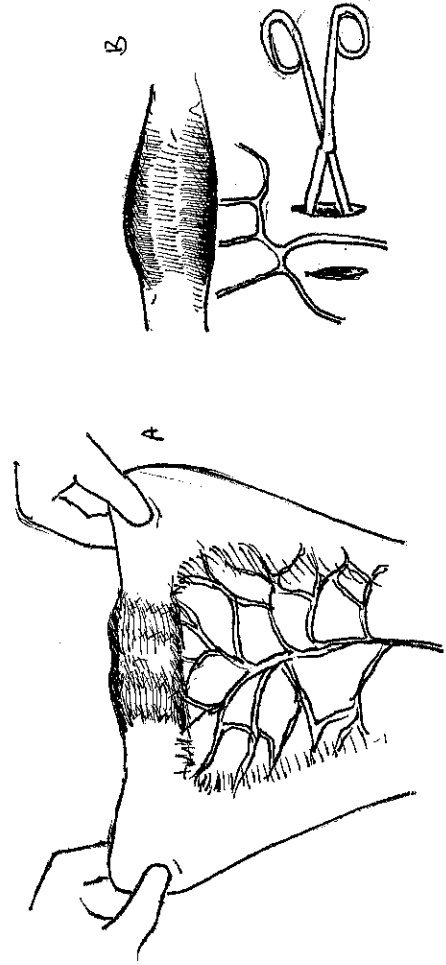
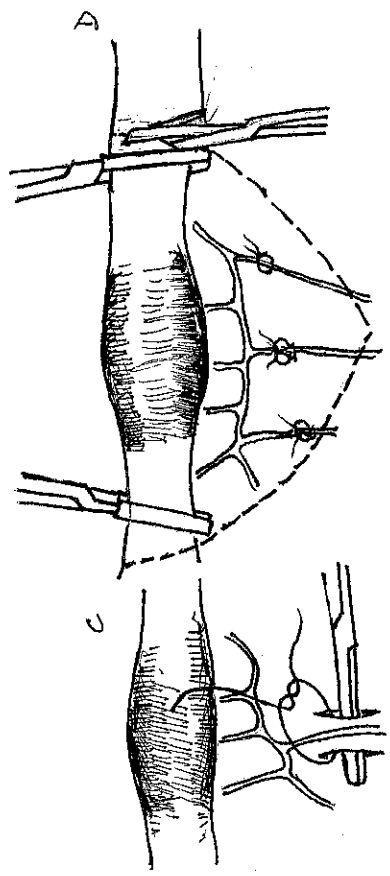
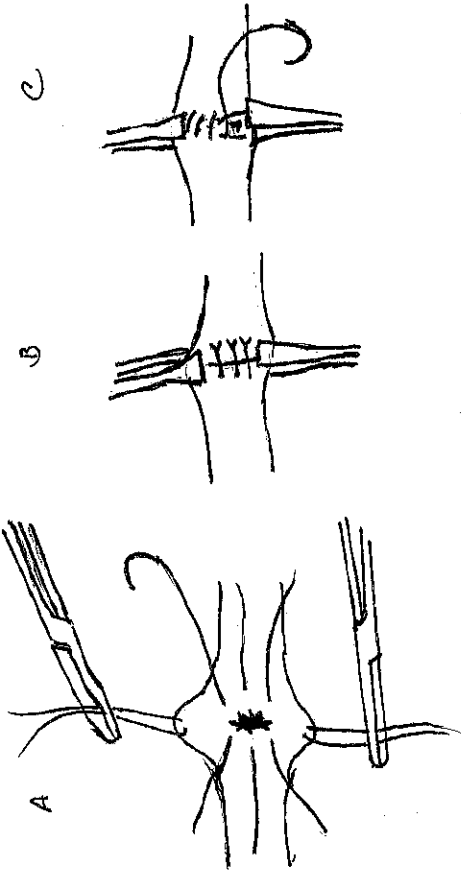

SW

5

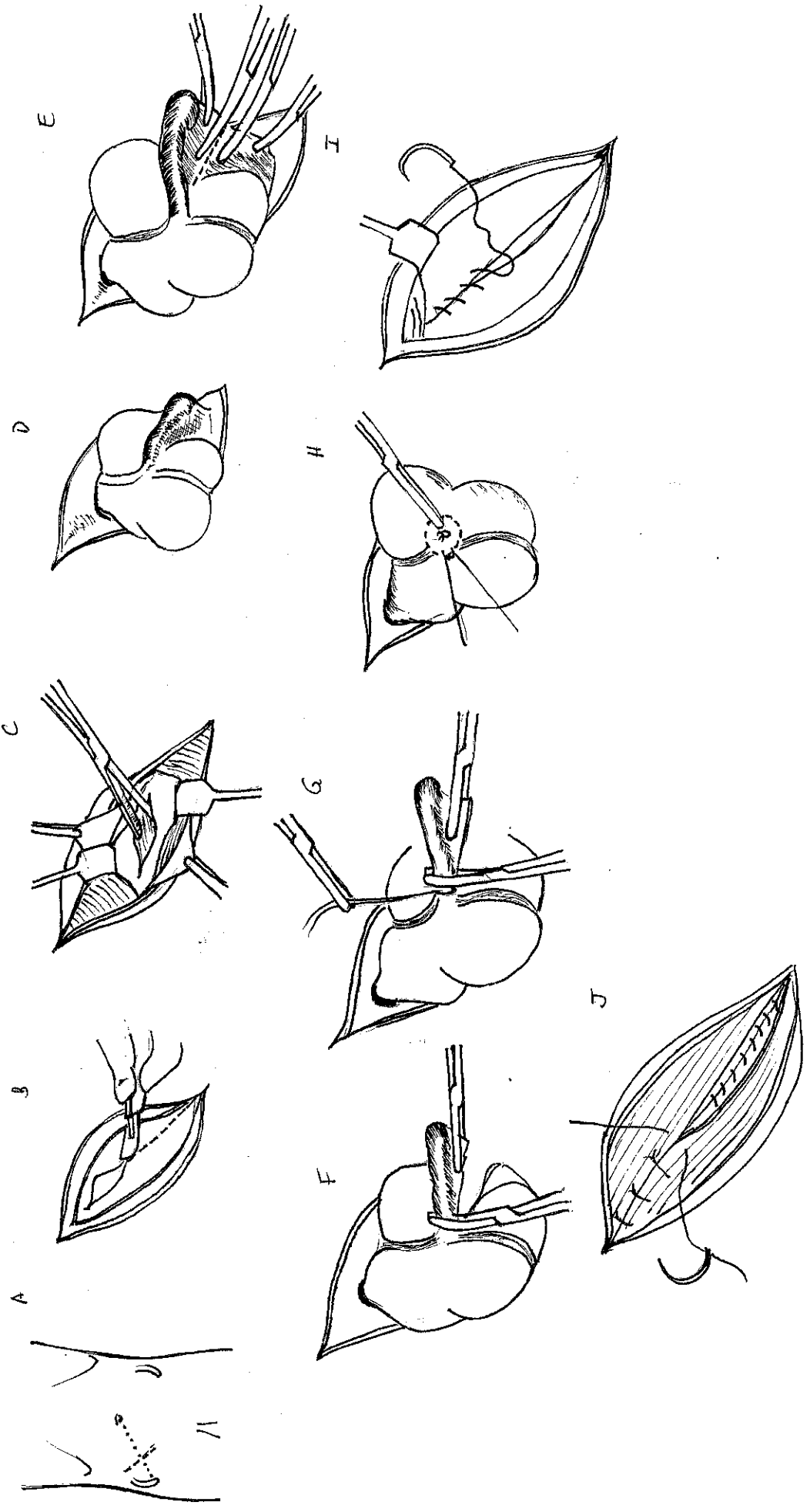
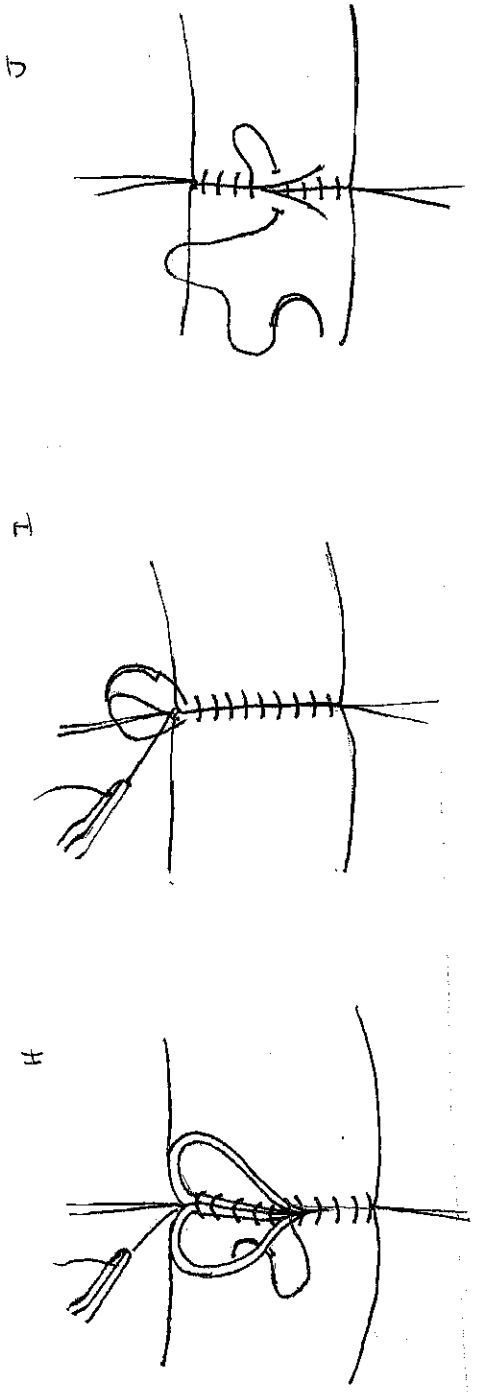

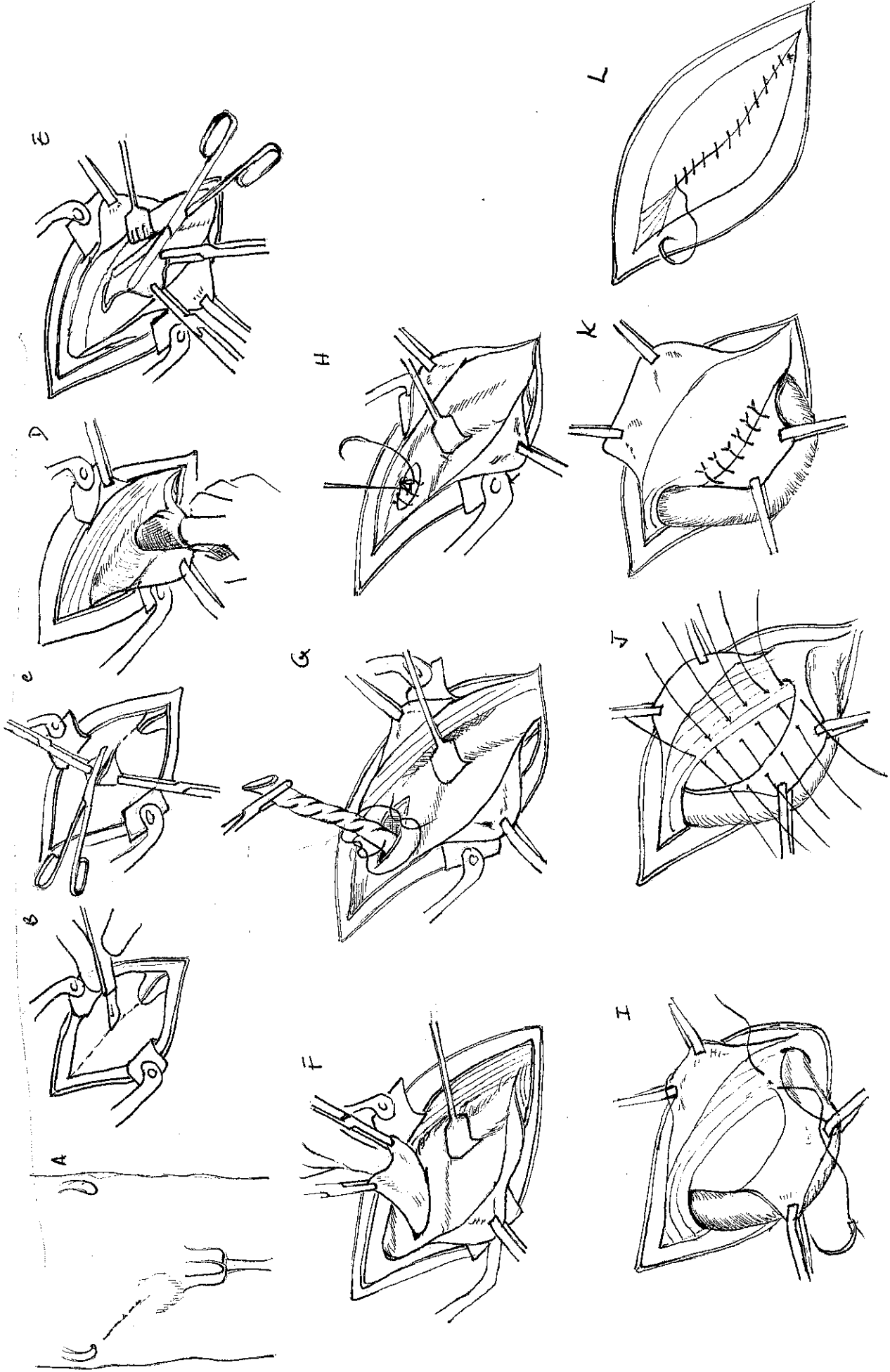
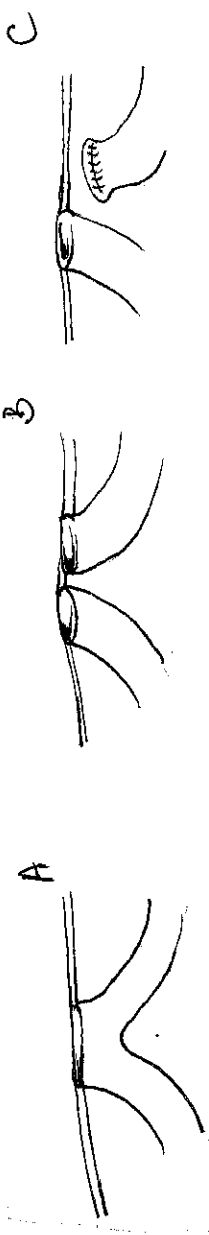

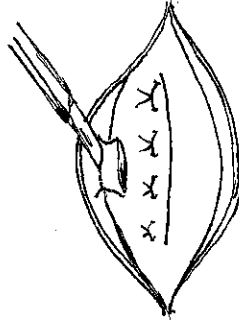
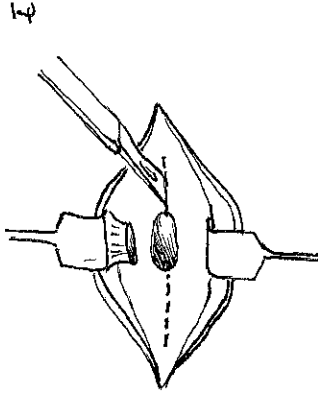
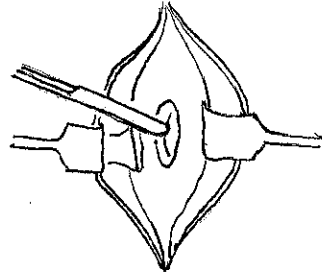
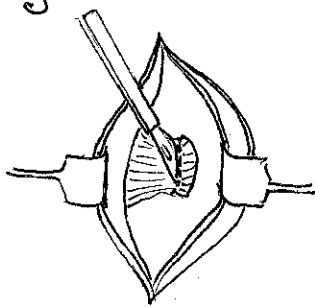
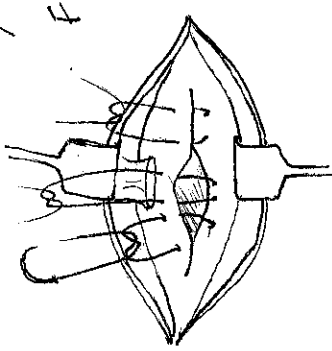
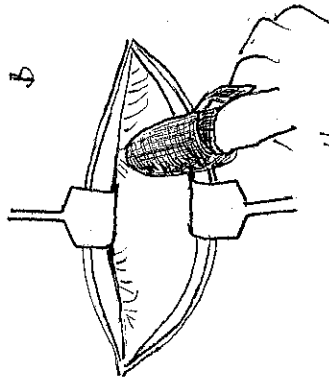
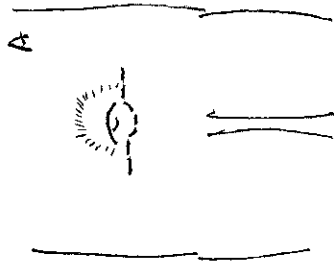
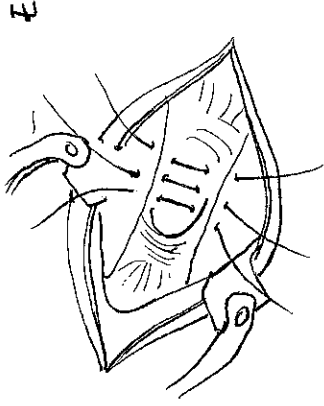
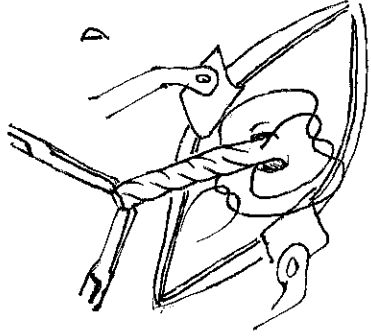
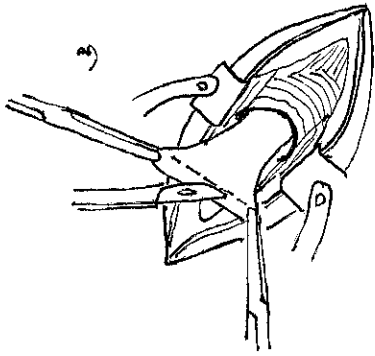

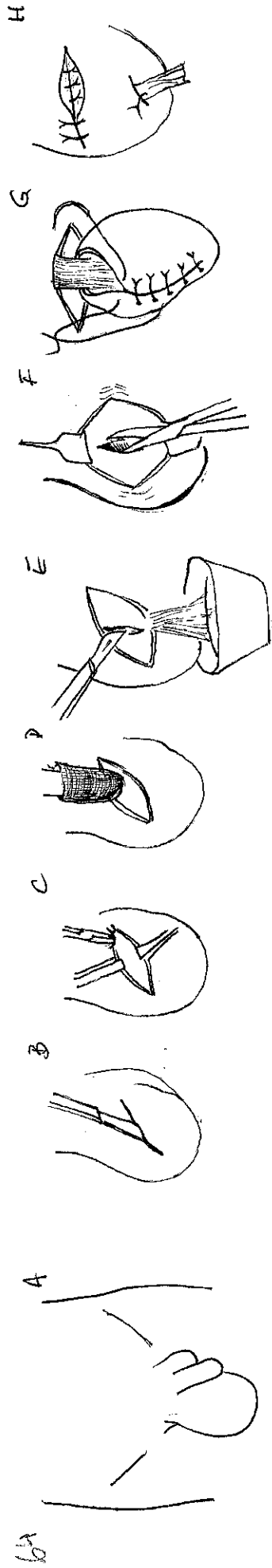
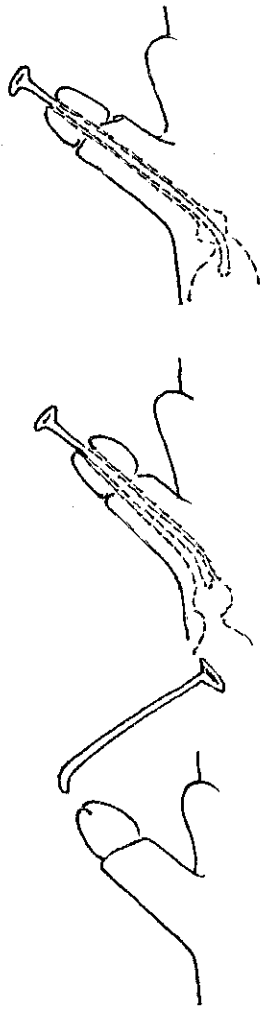
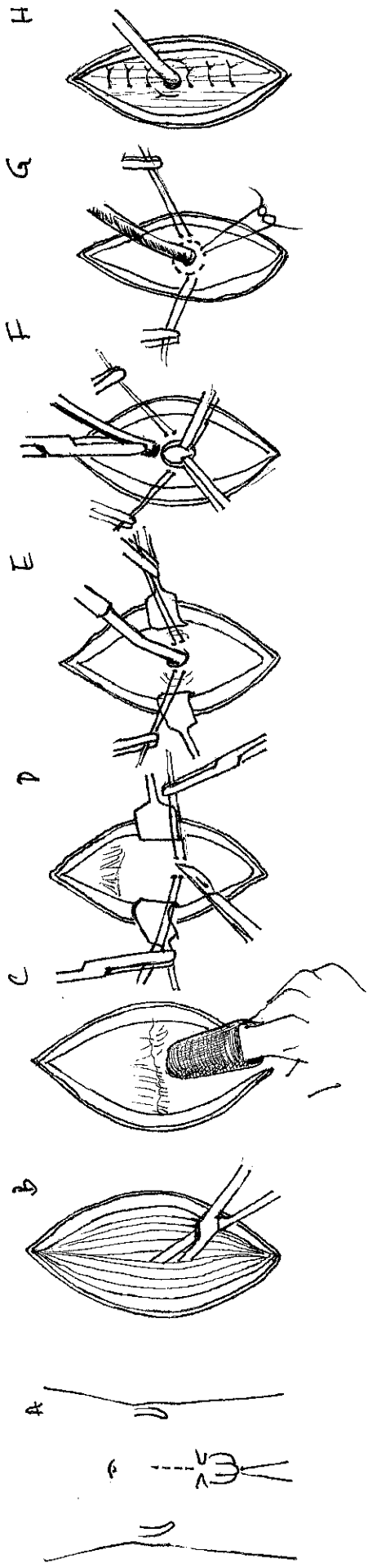

65

A

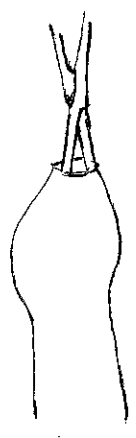

B

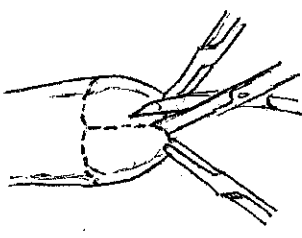

C

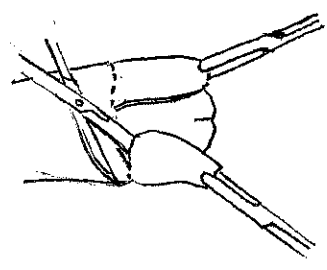

D

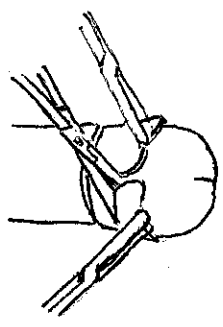

E

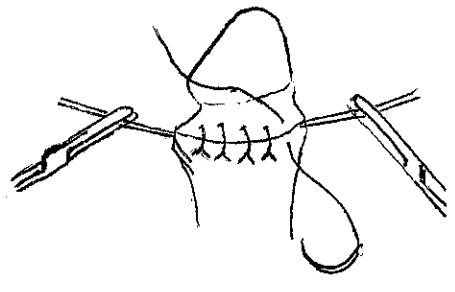

66

A

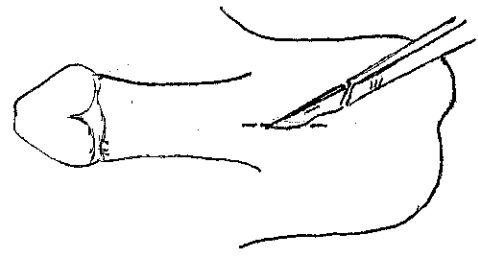

B

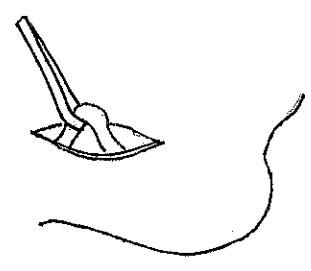

C

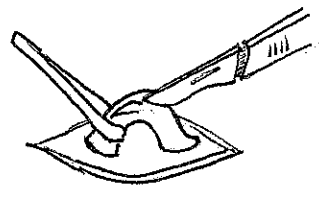

D

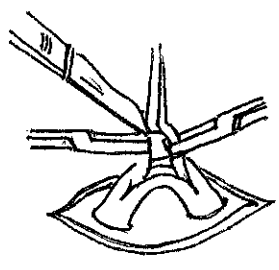

E

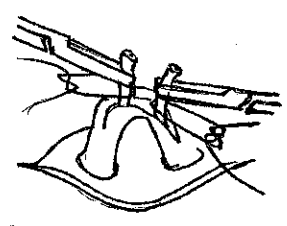

F

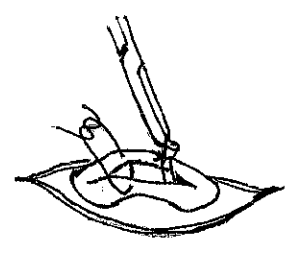

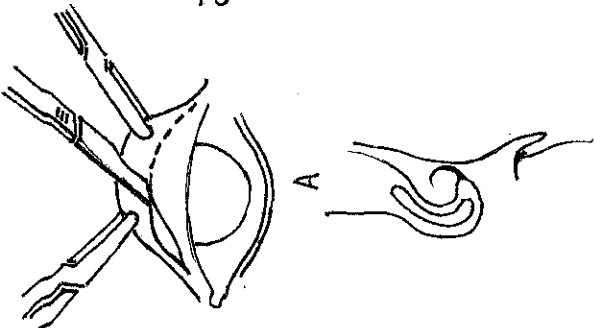
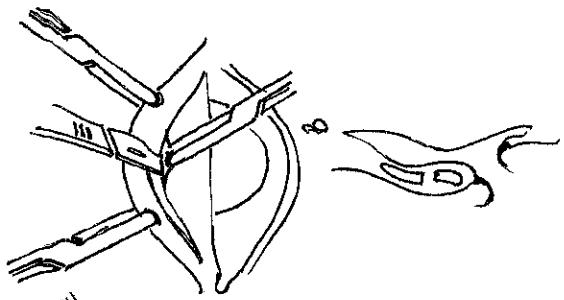
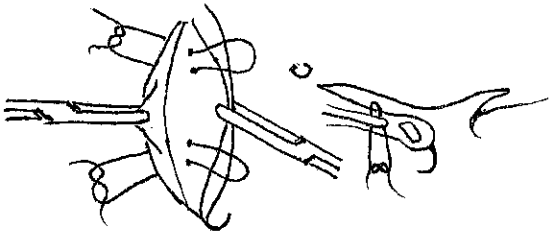
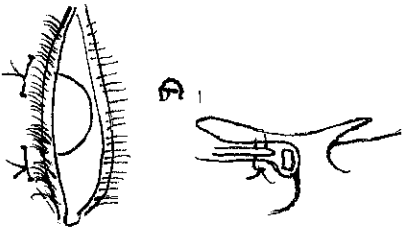

38

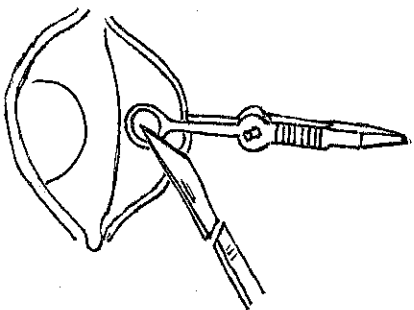
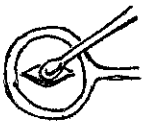

39

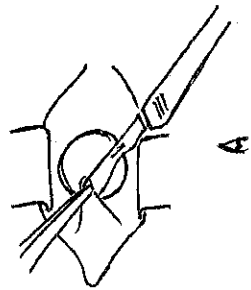
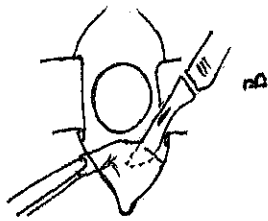
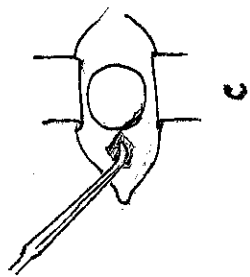

41



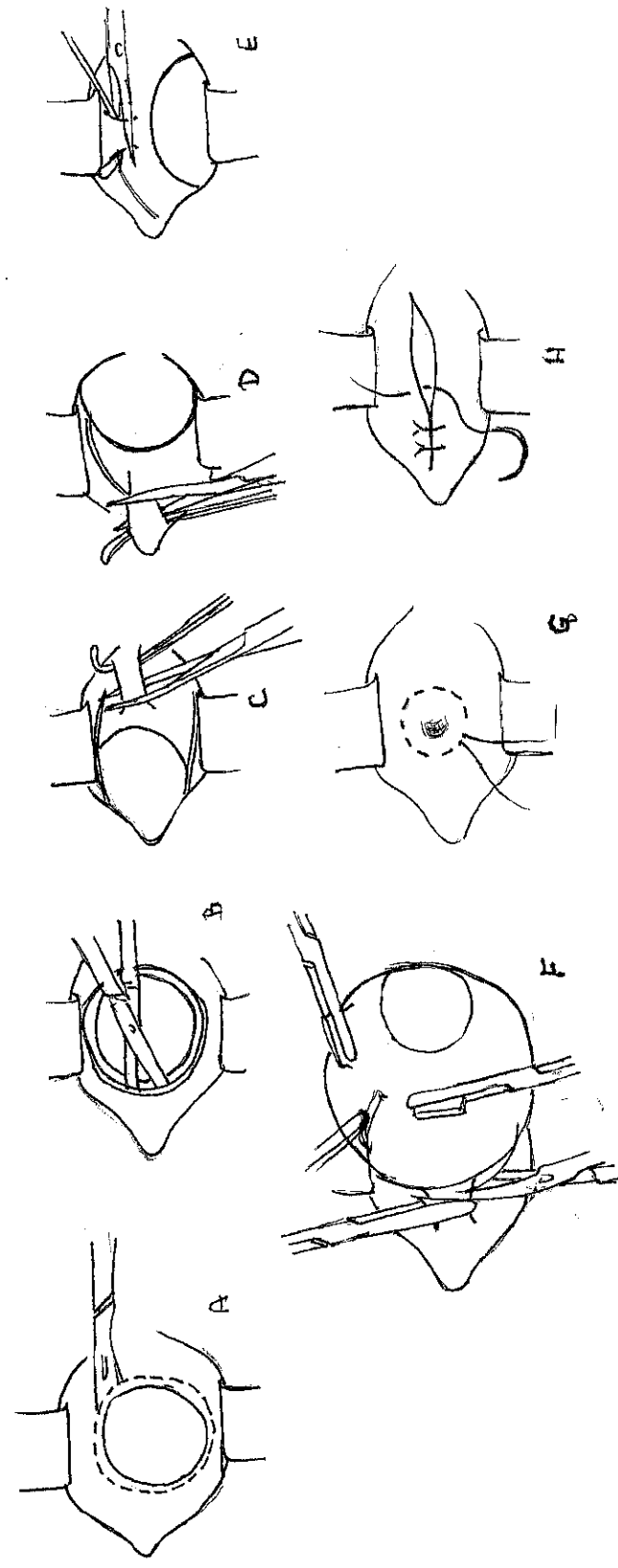
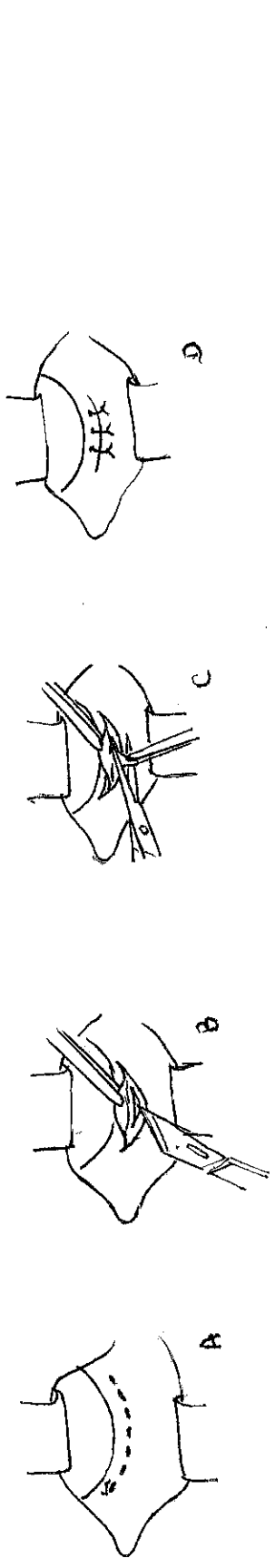
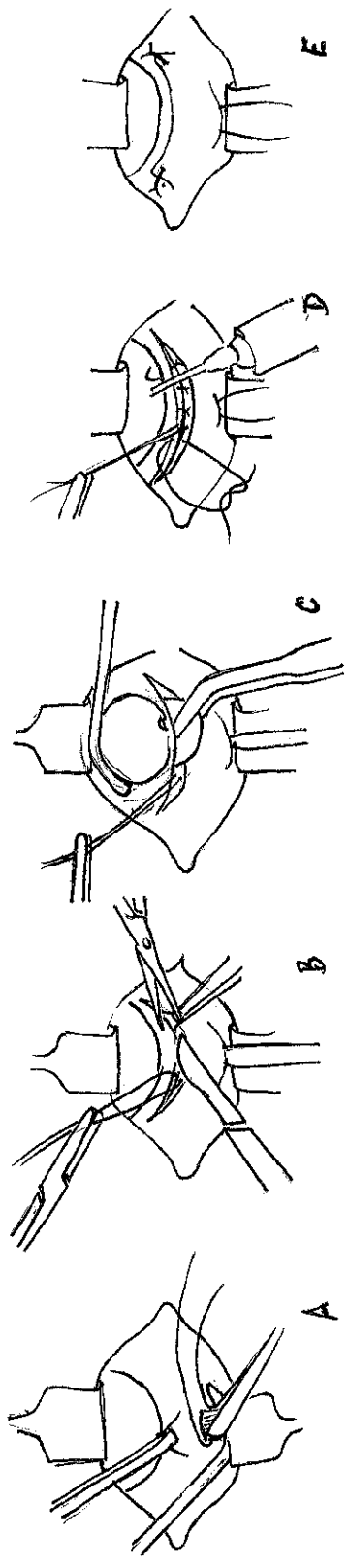



73

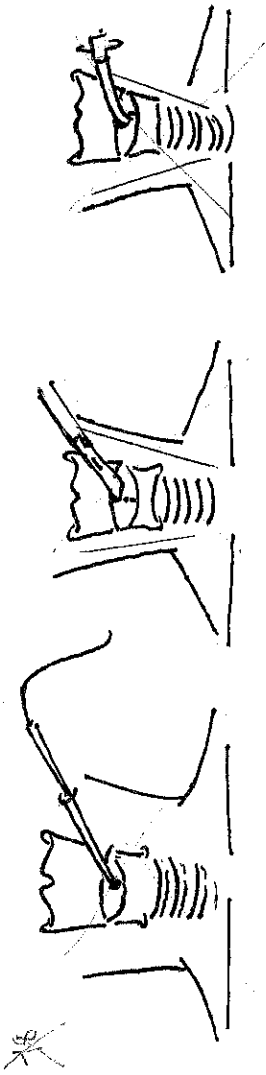

74

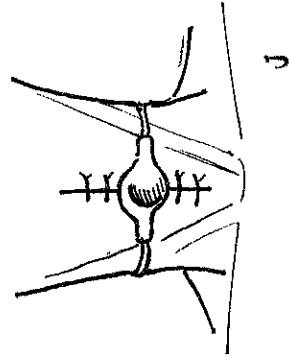
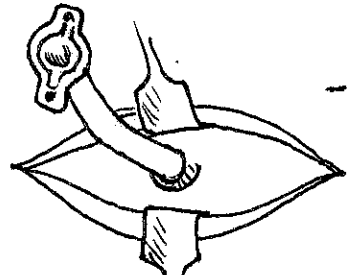
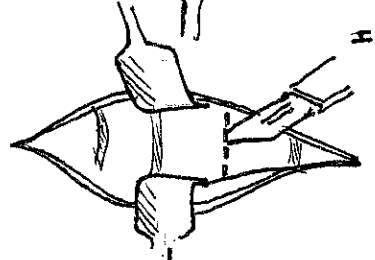
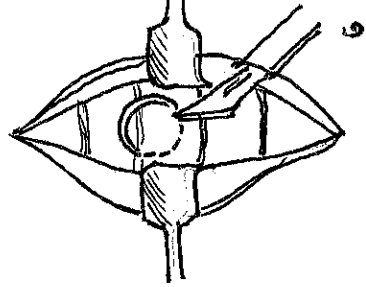
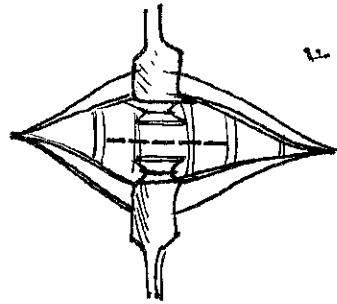
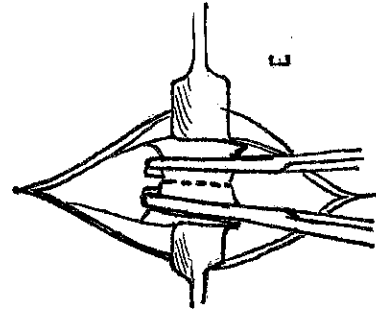
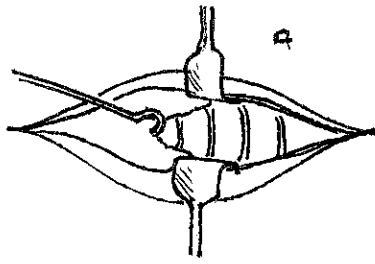
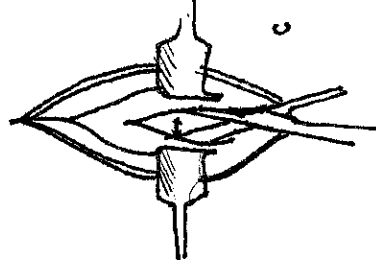
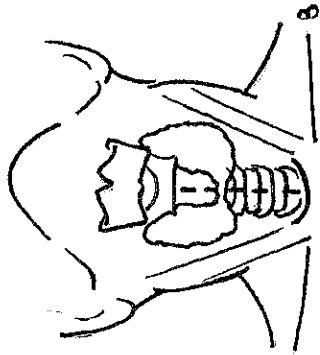

75

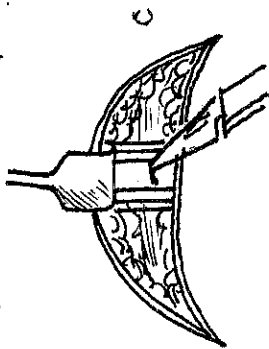
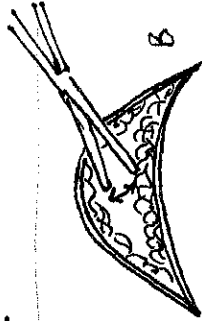
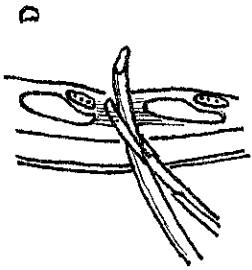
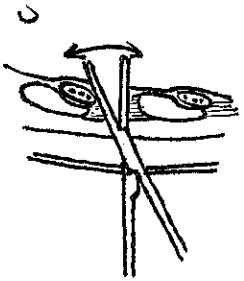
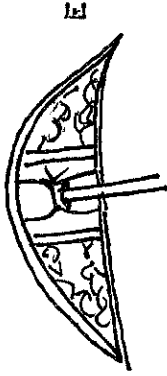
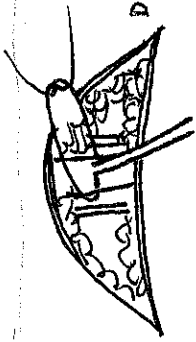
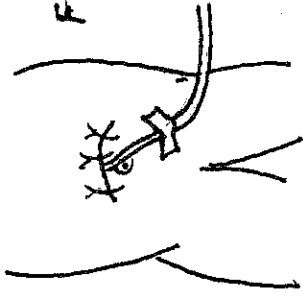
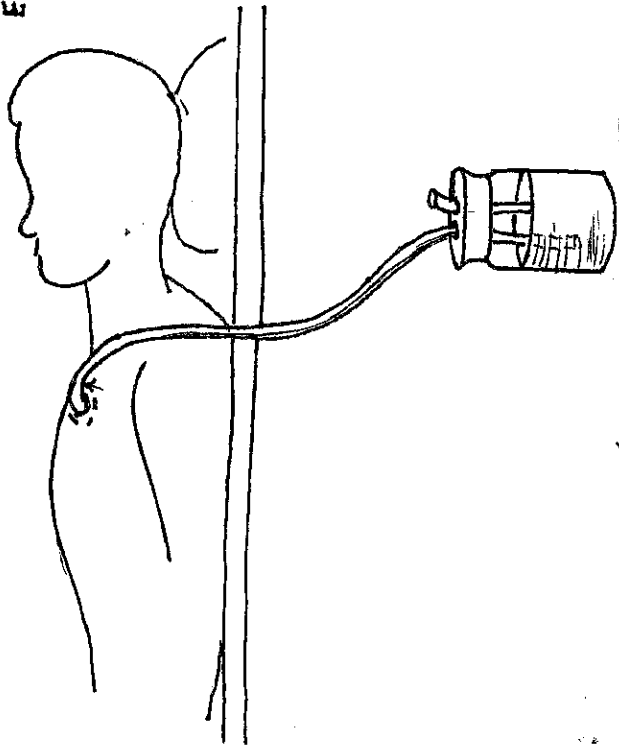

76

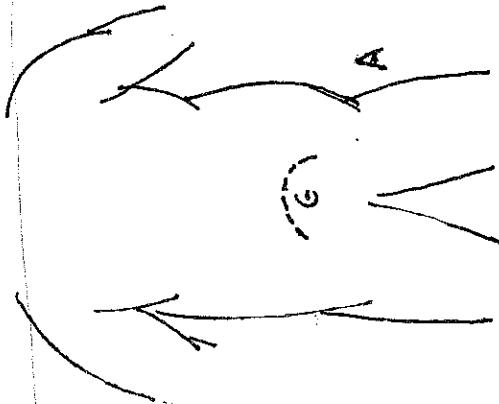
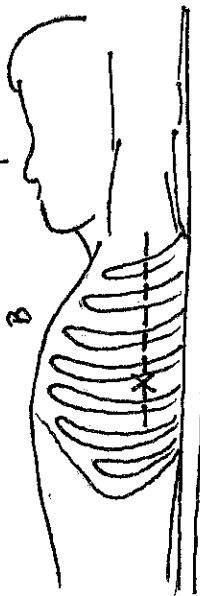
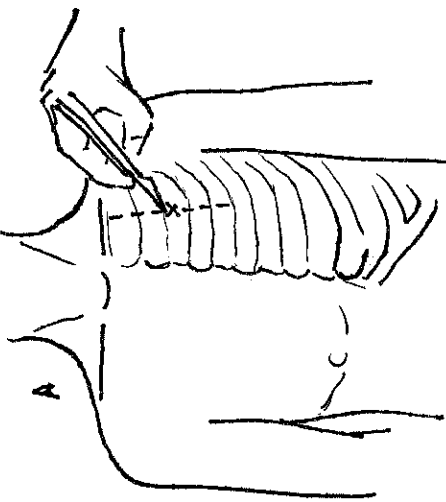

77



77

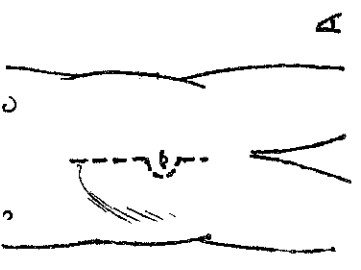

A

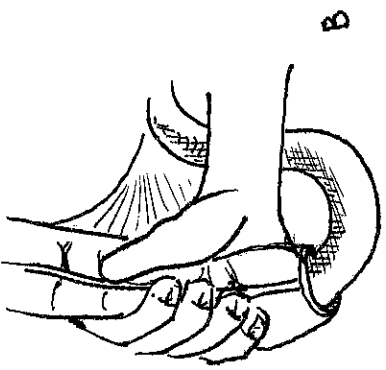

B

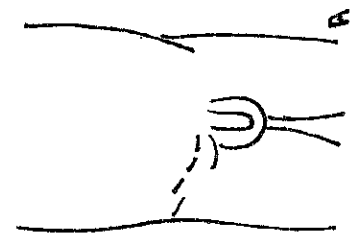

A

78

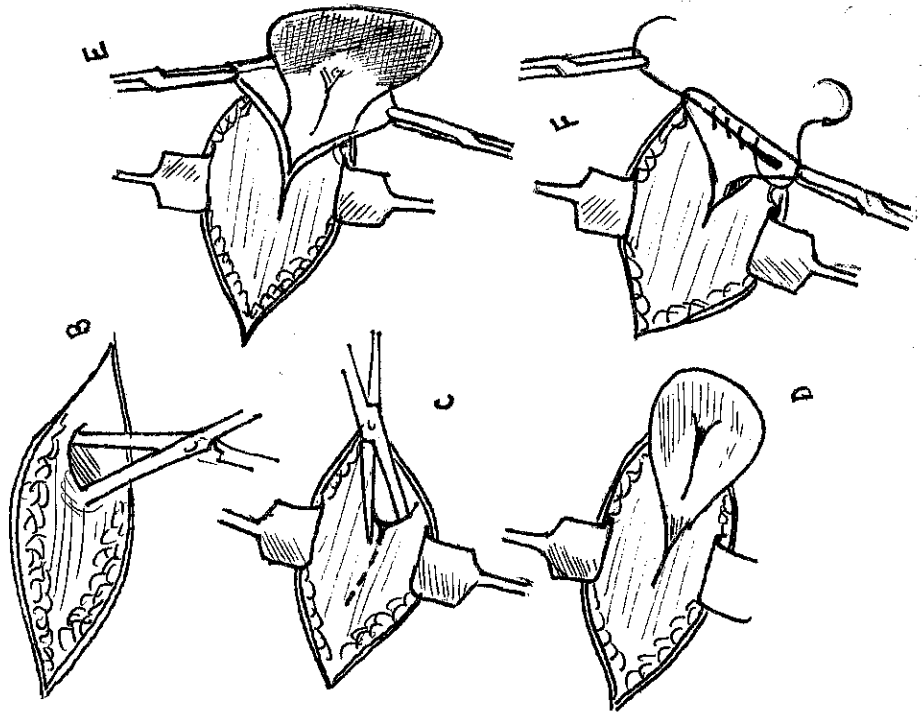

B

C

D

E

F

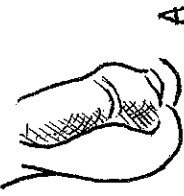
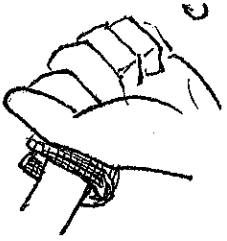

18

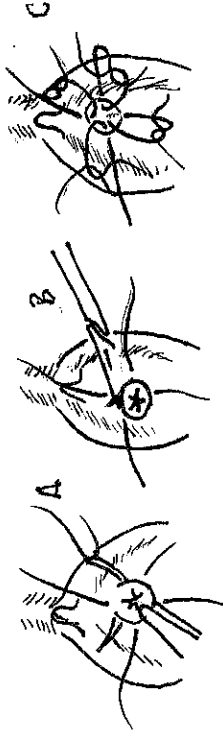

19

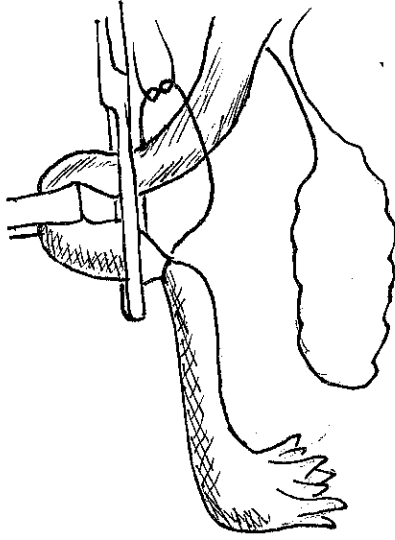

20

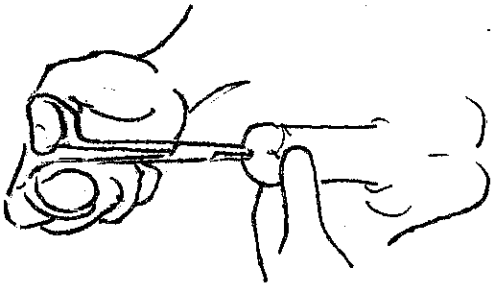

21

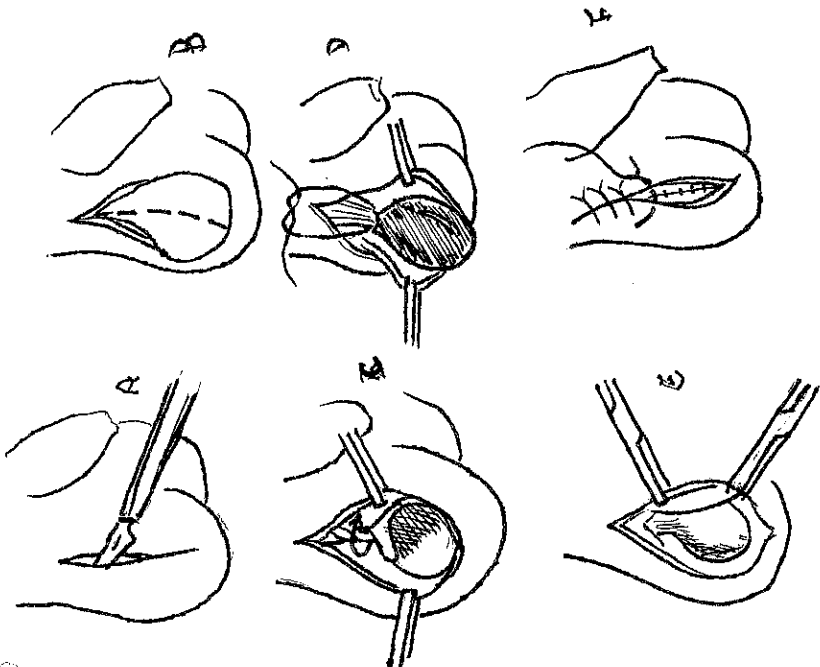

22

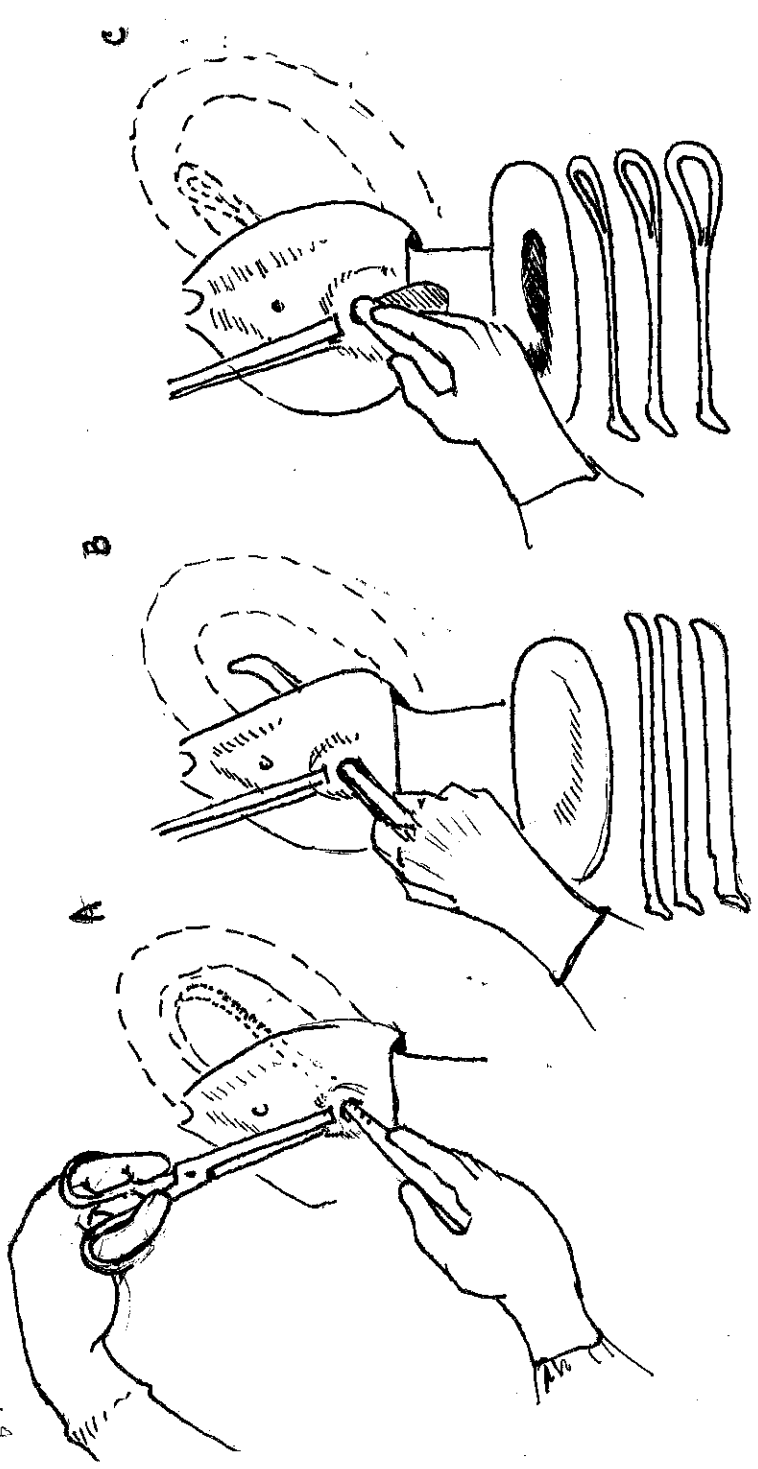

85

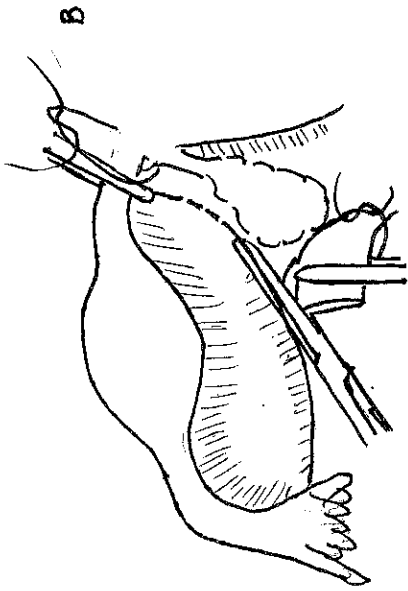
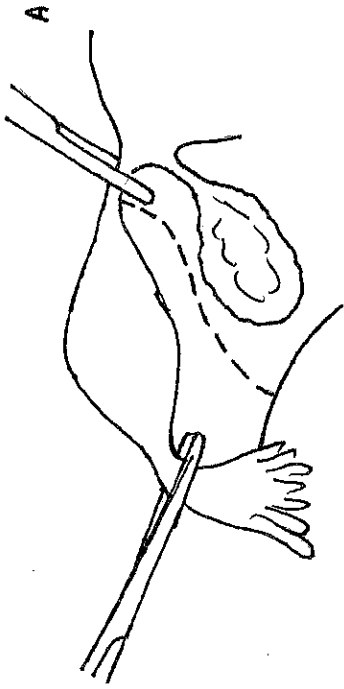

86

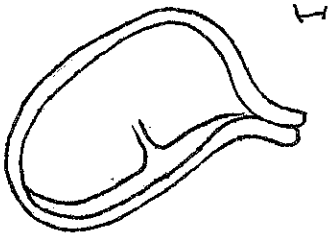

I

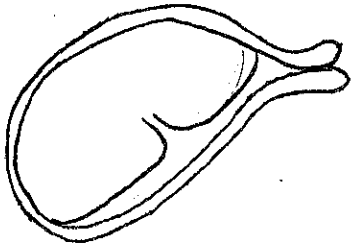

II

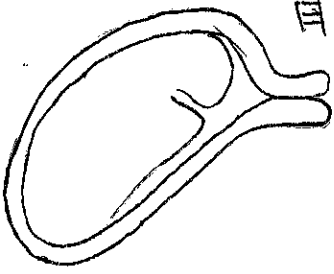

III



IV

87

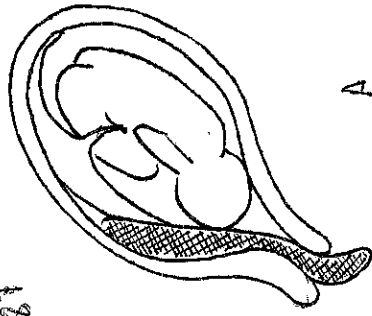

A

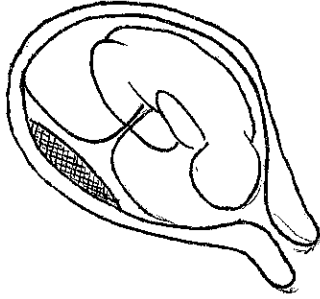

B

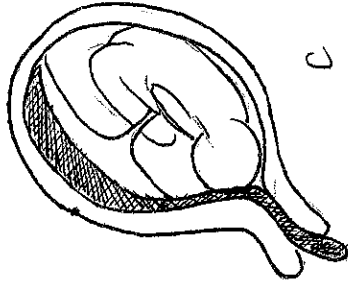

C

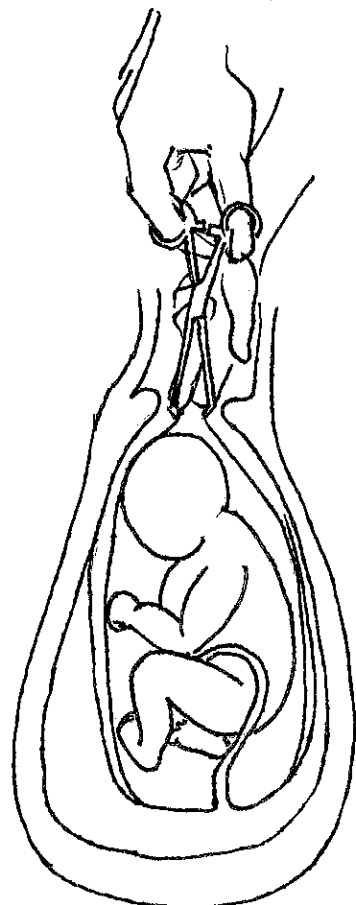
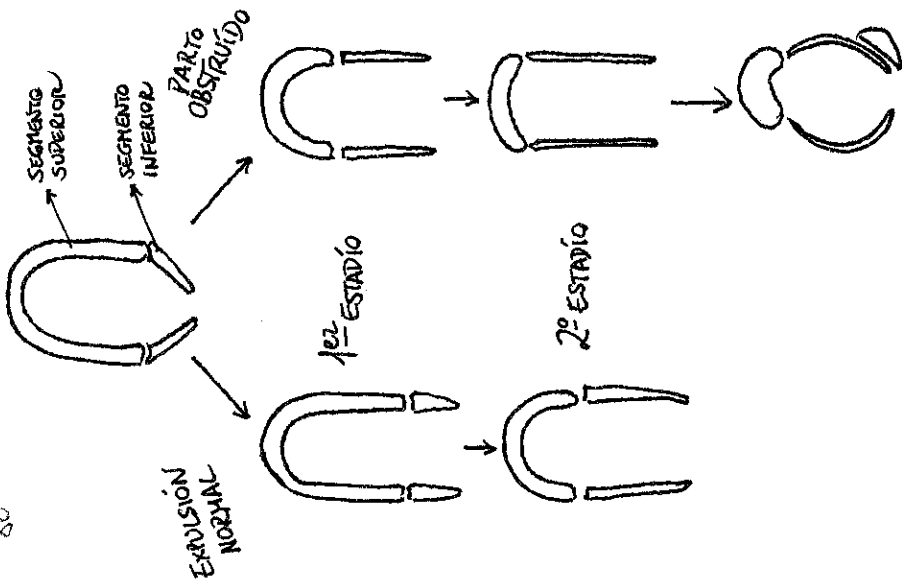
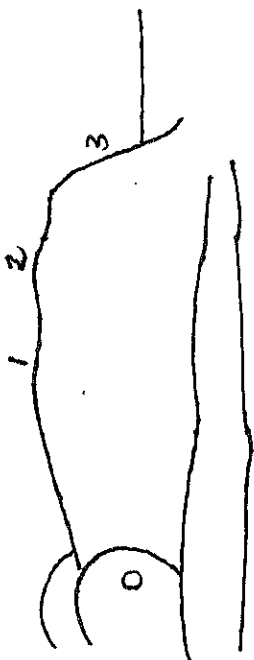



95

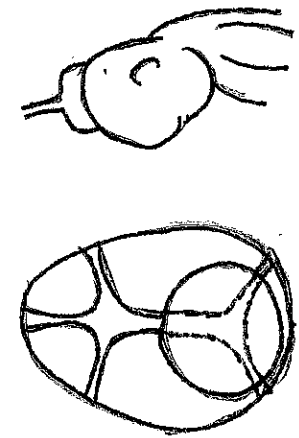
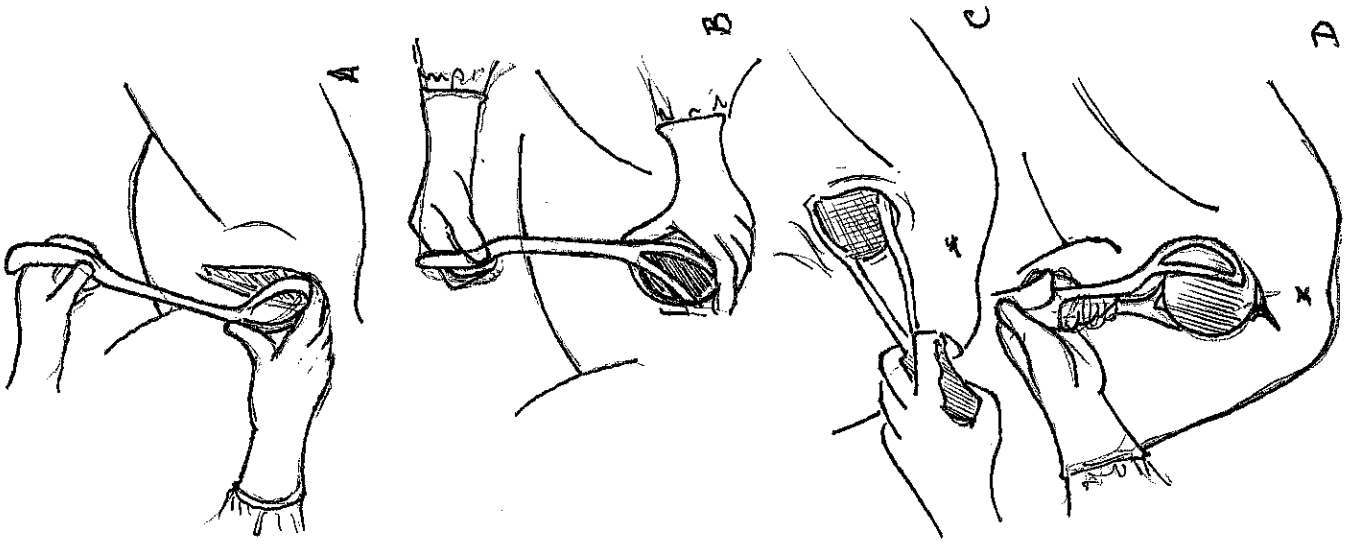

96

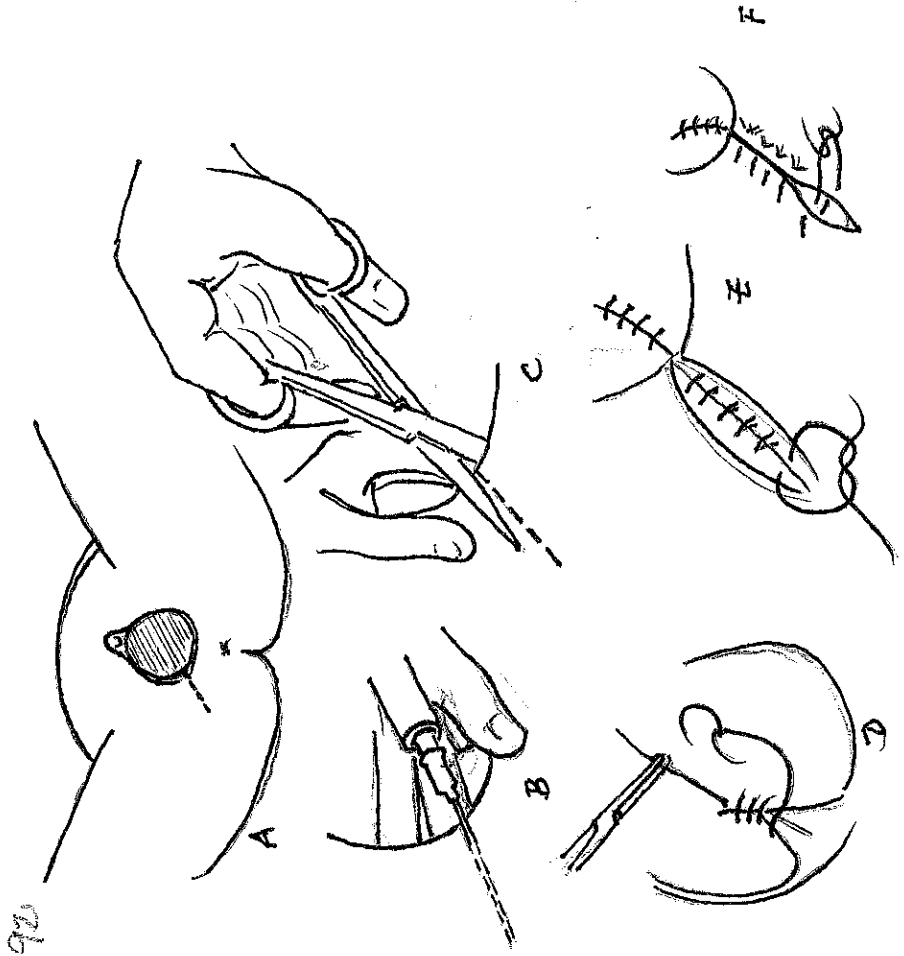



46

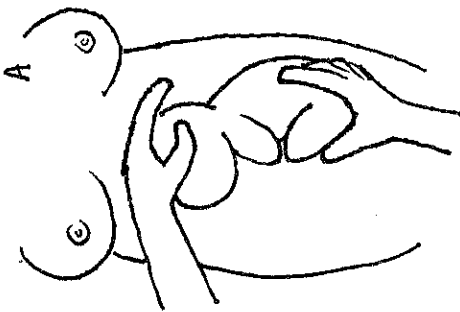
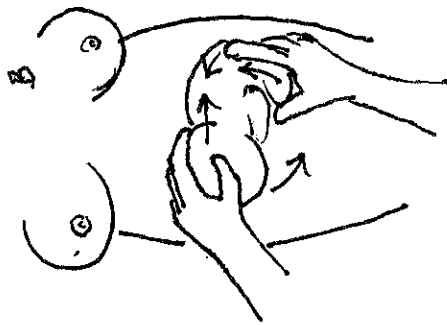
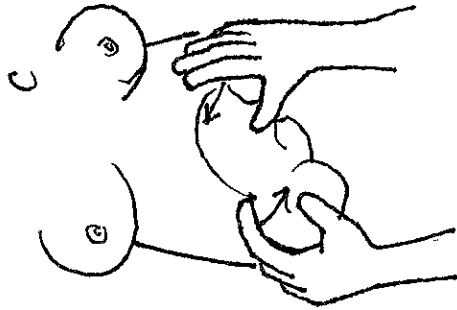

46

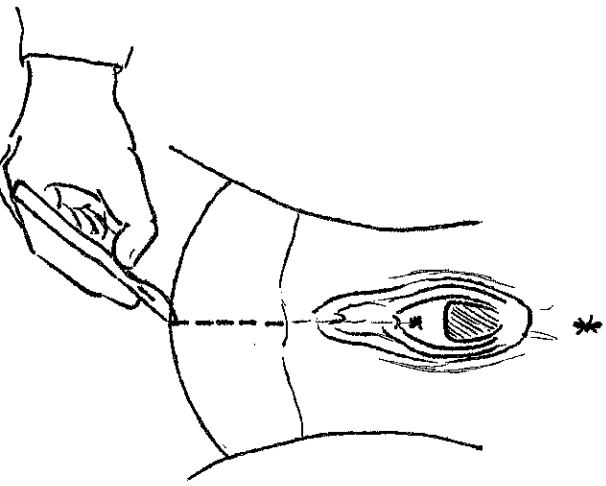

46

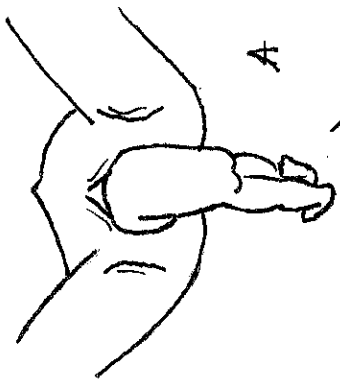

A

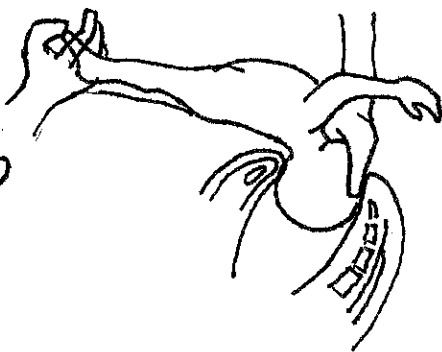

C

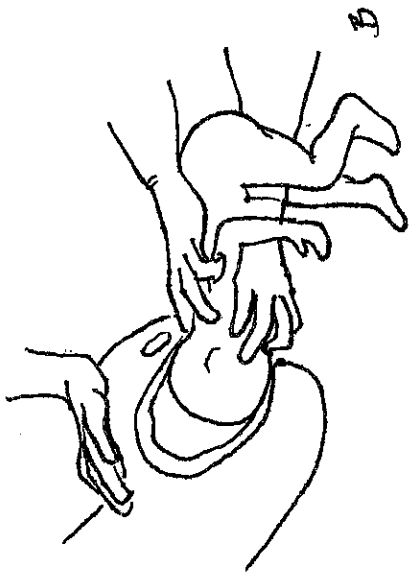

B

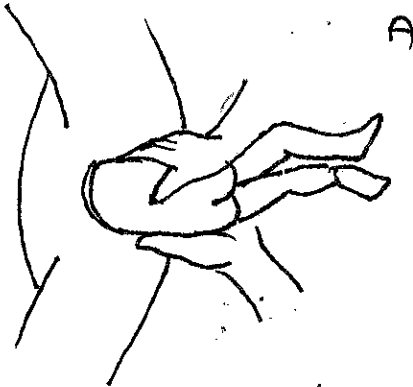

D

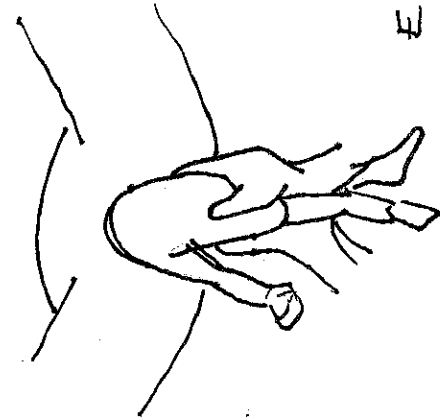

E

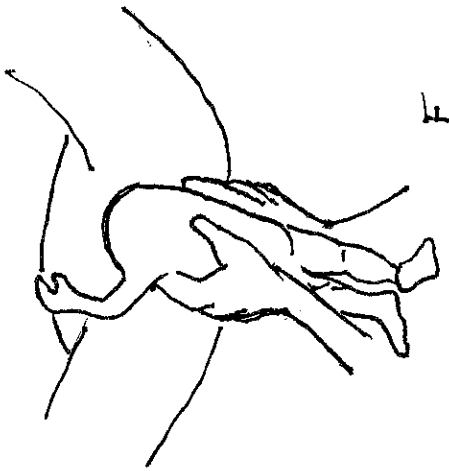

F

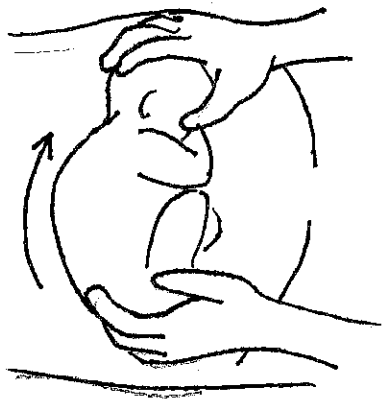

98

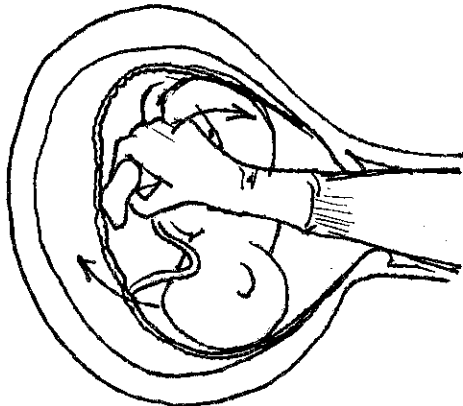

99

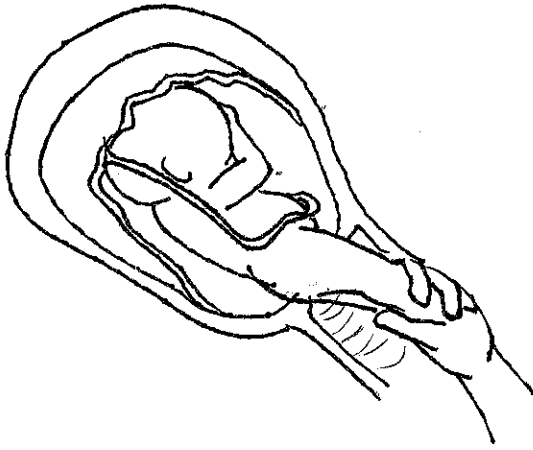

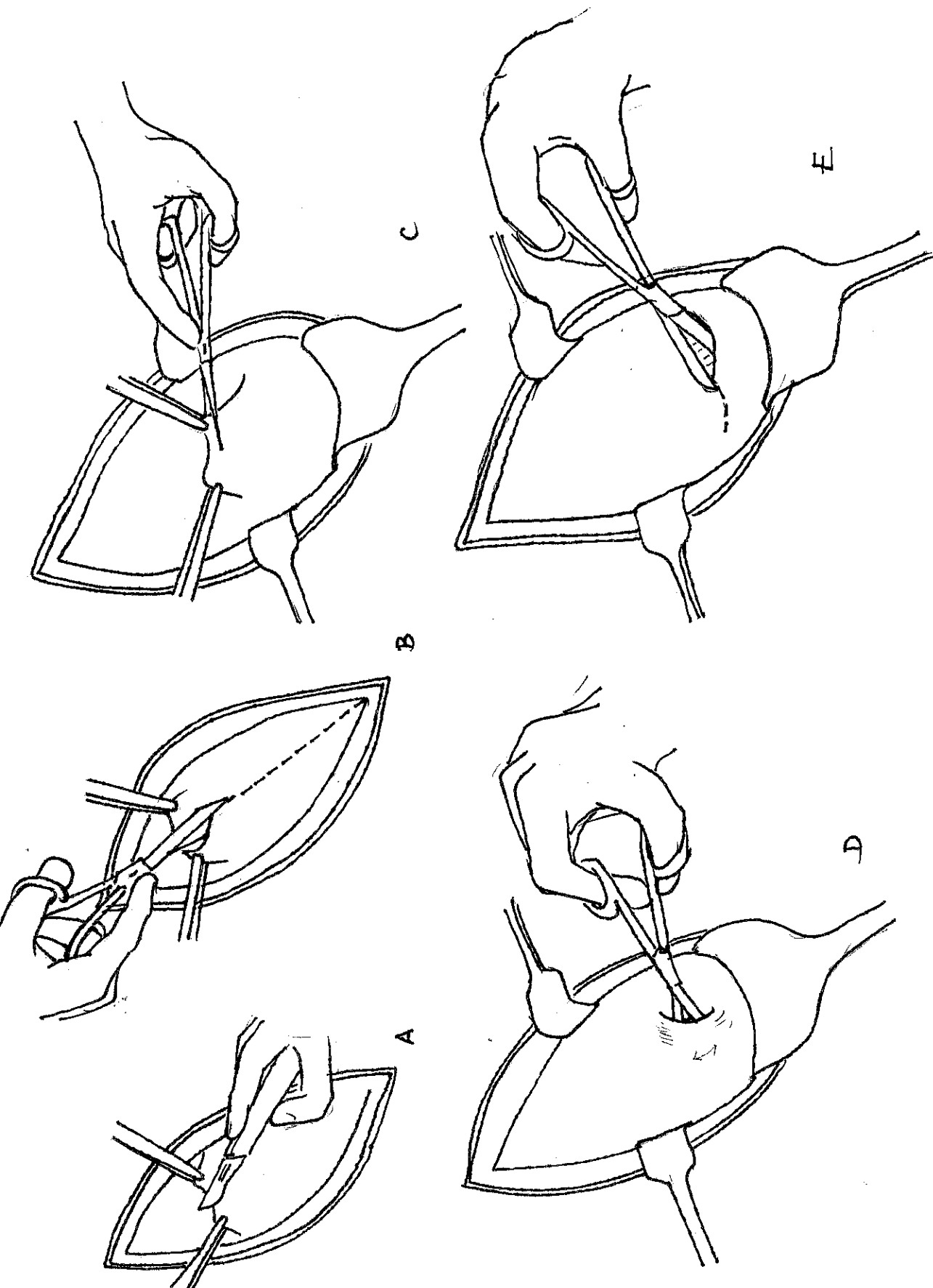

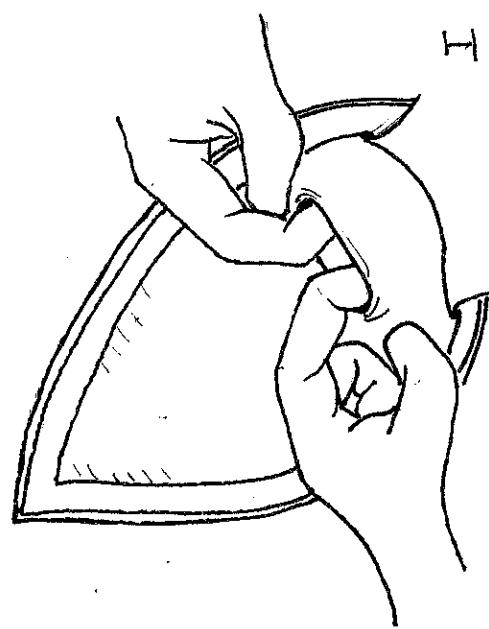
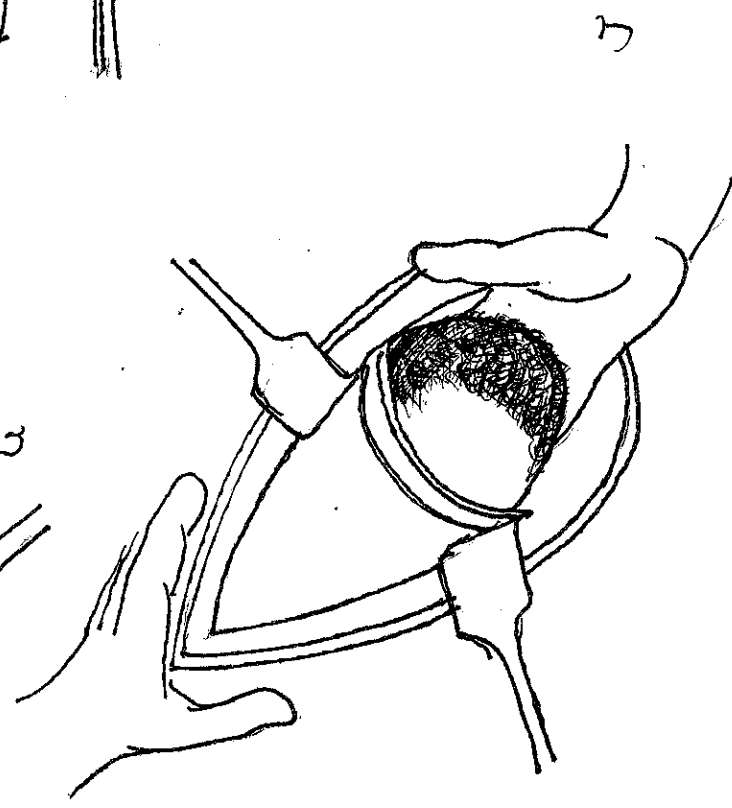
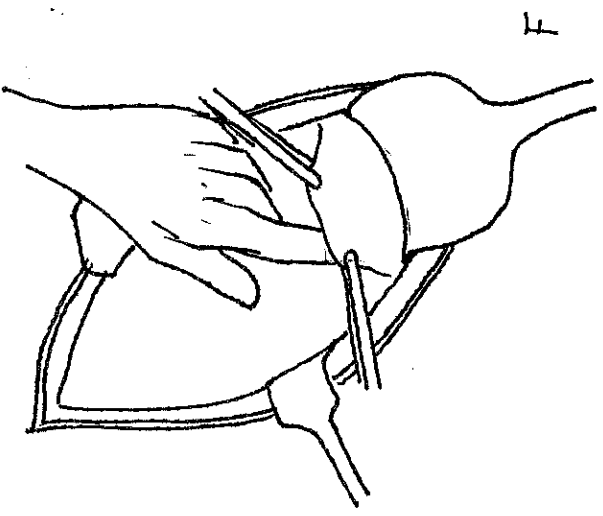
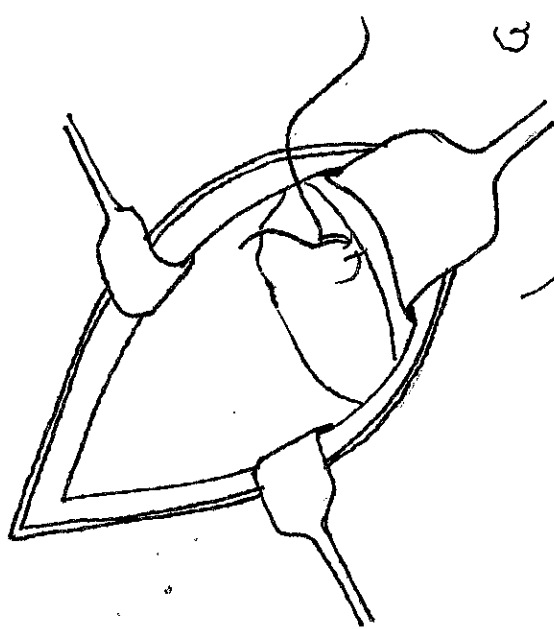
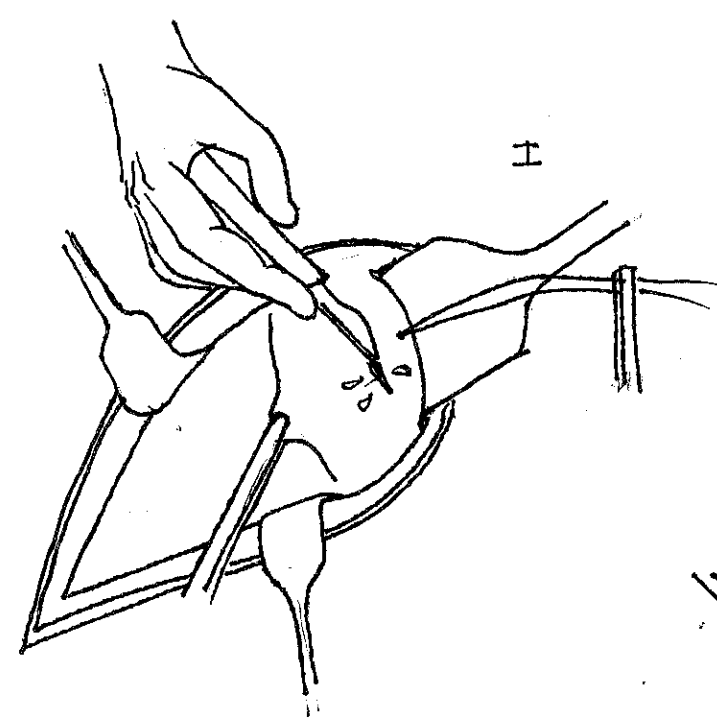

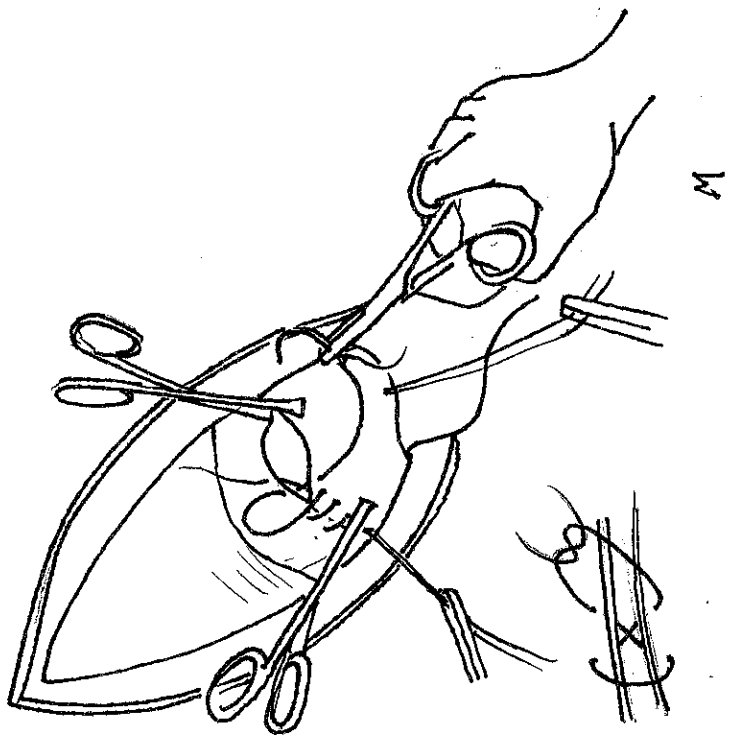
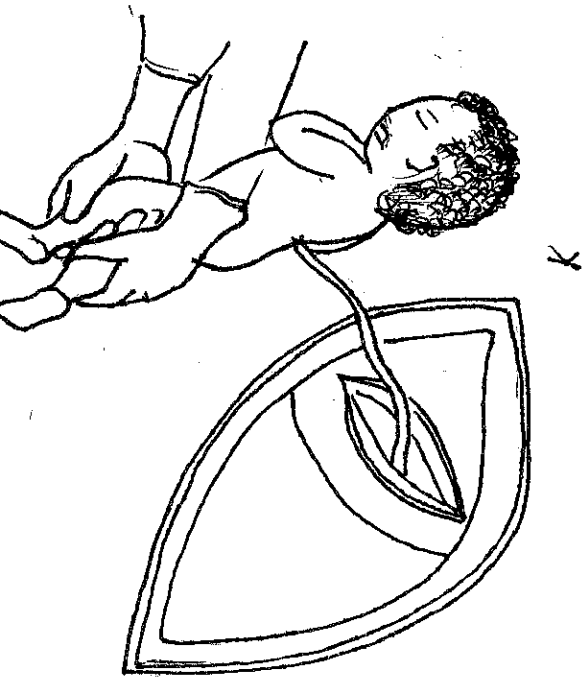
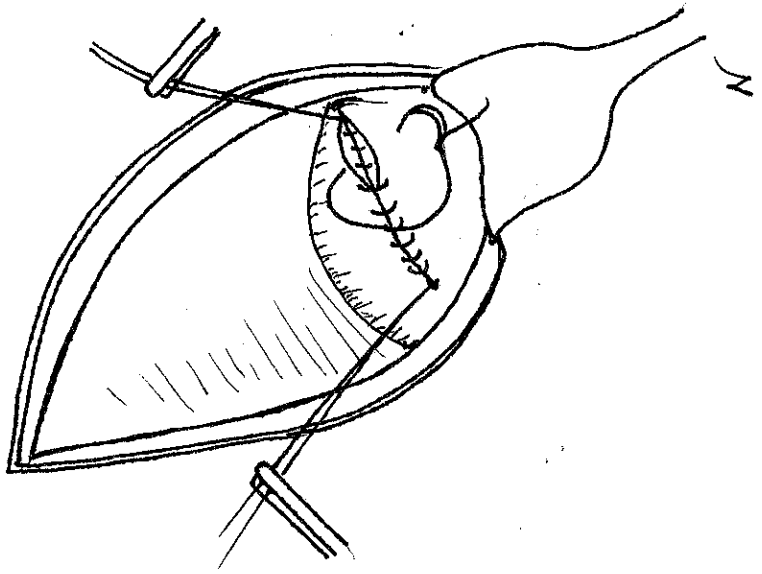
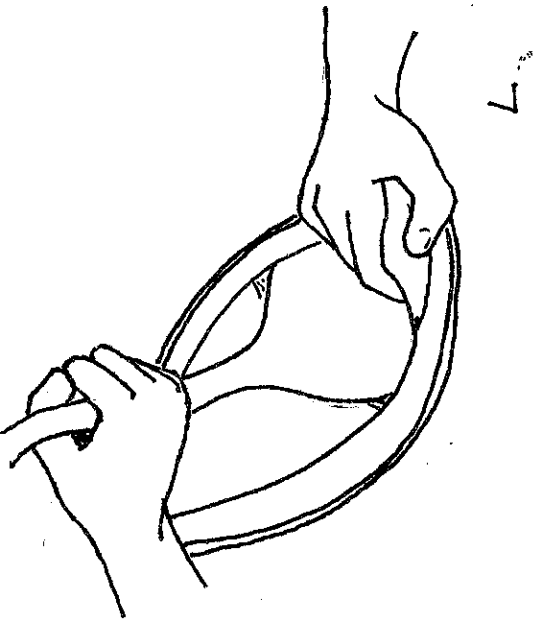
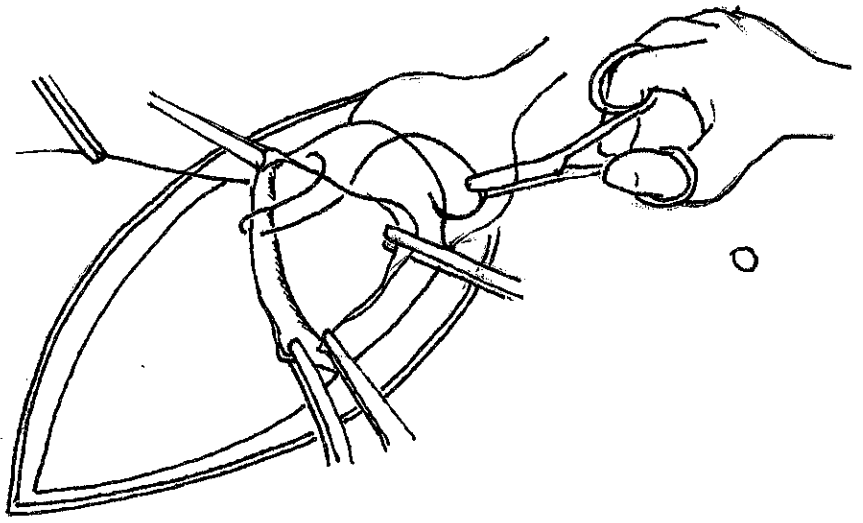

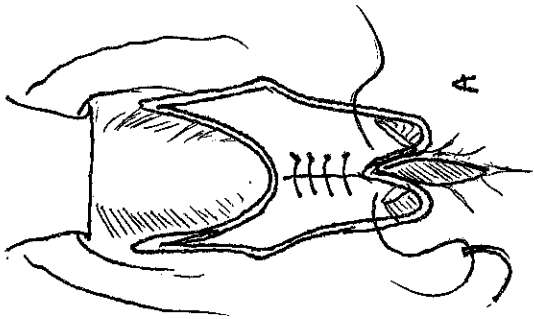
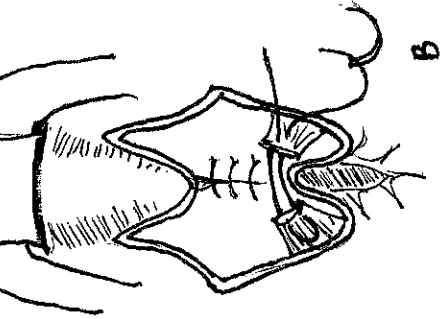
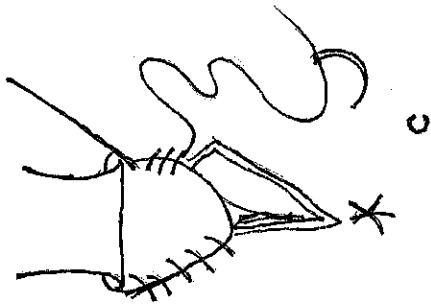
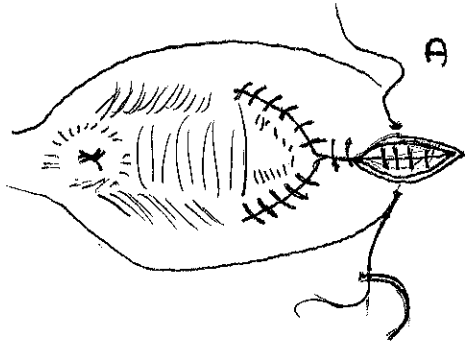

103

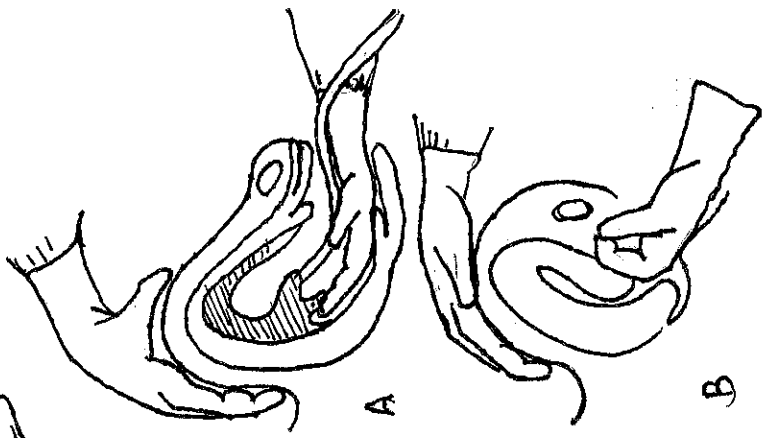
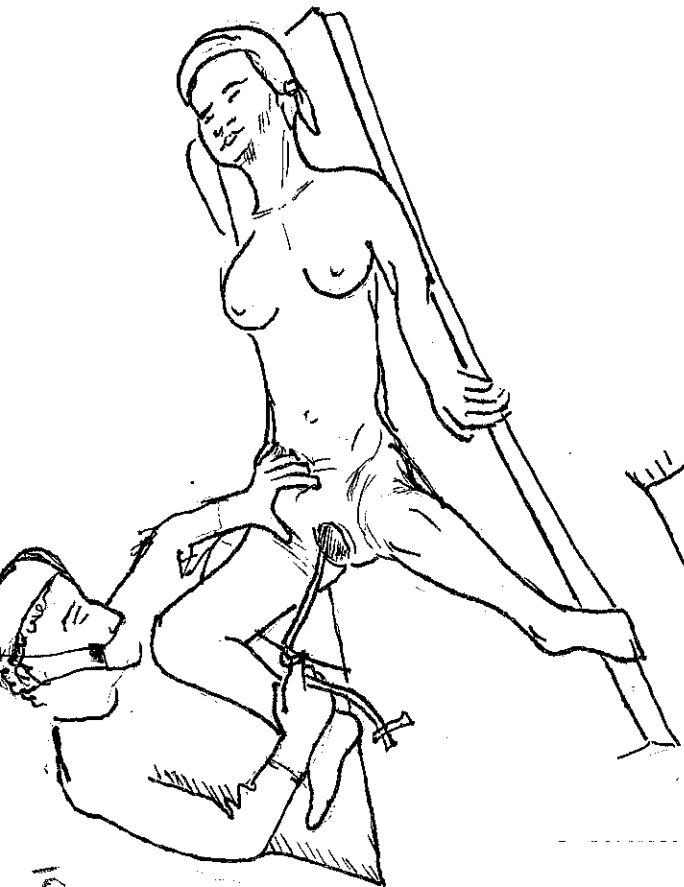

102



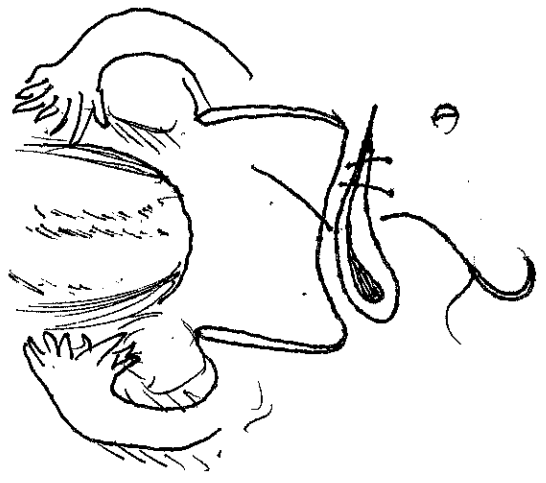
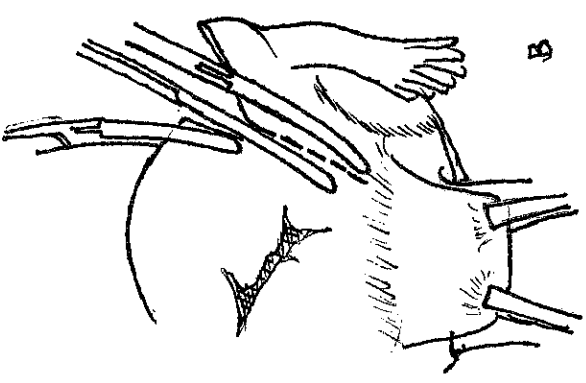
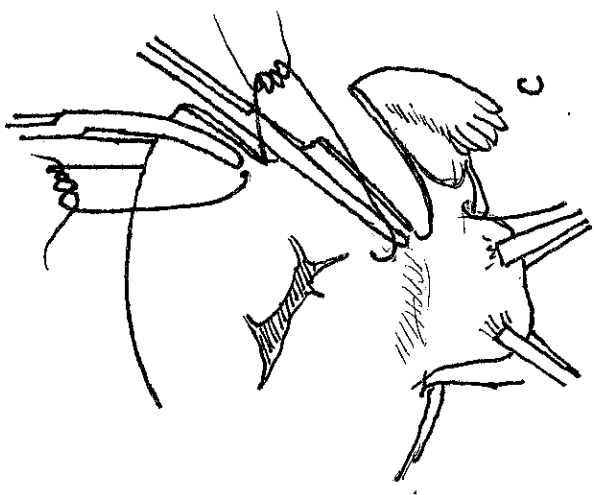

150

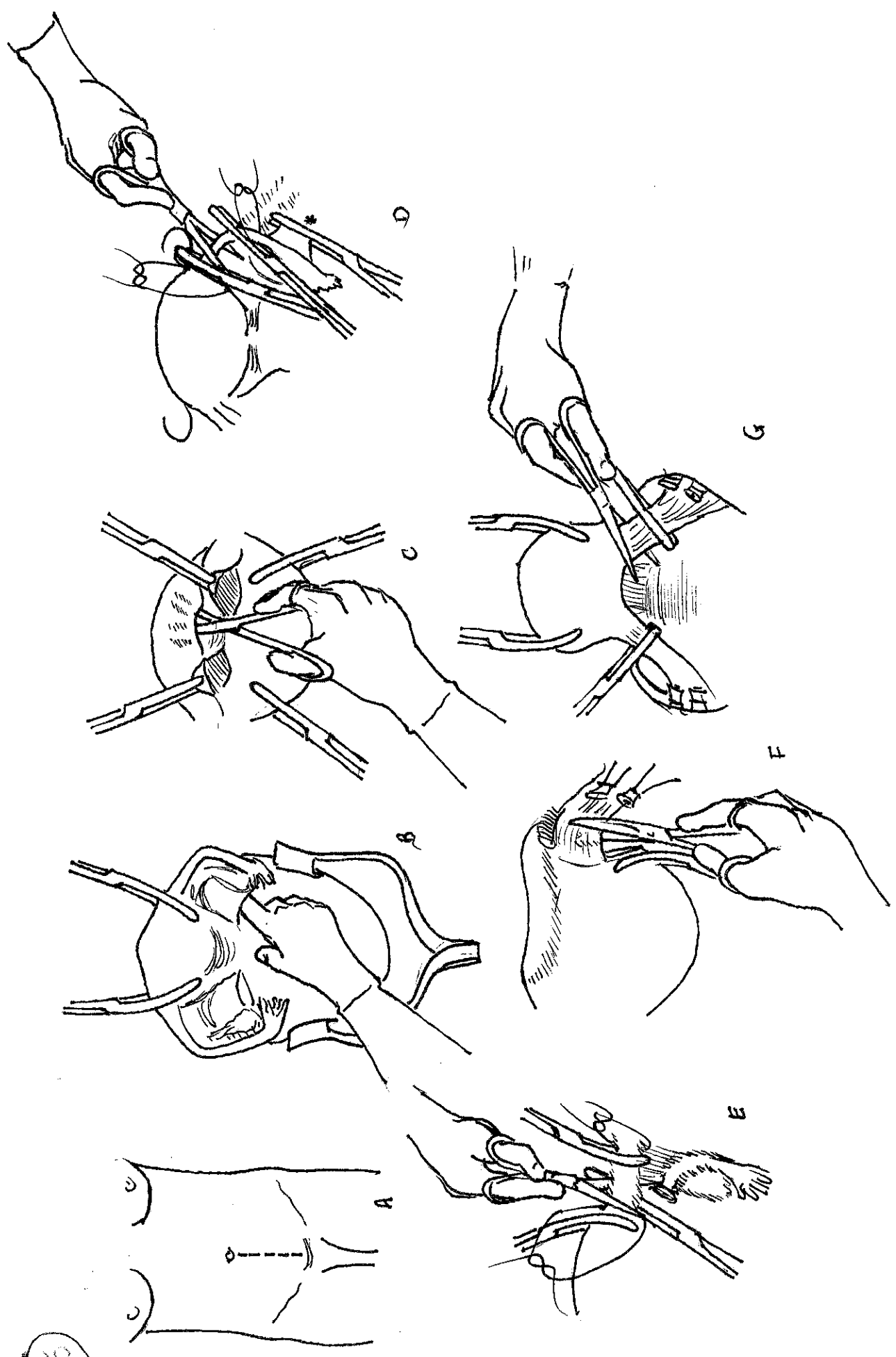

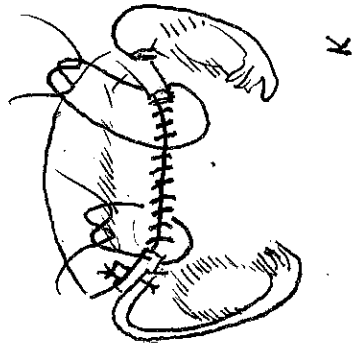
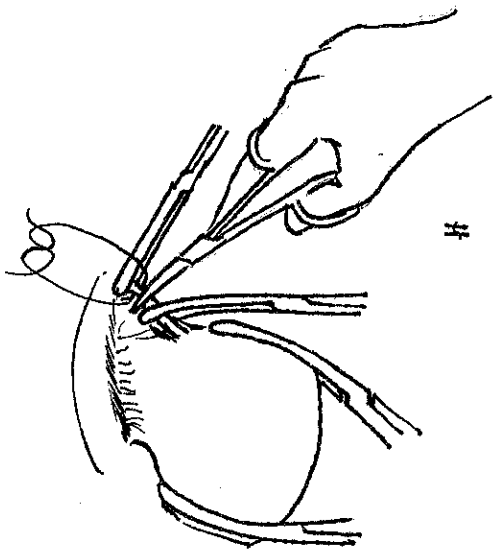
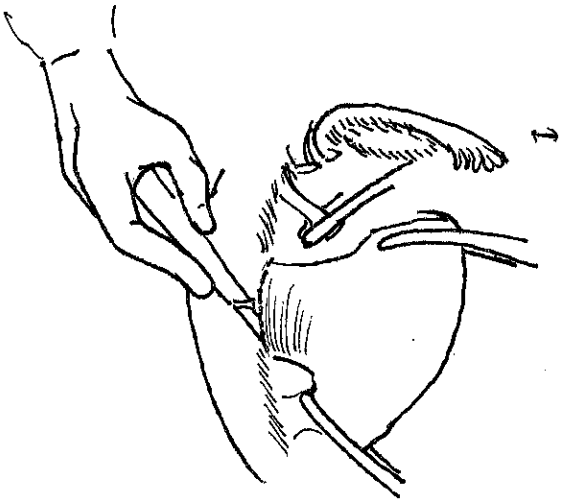
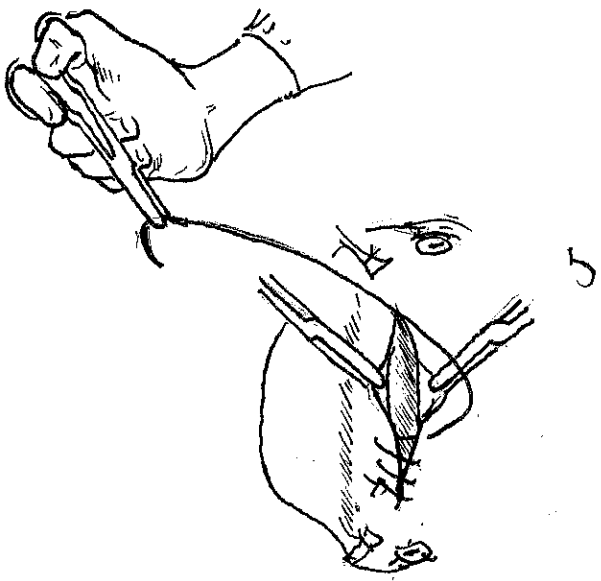

...LOS

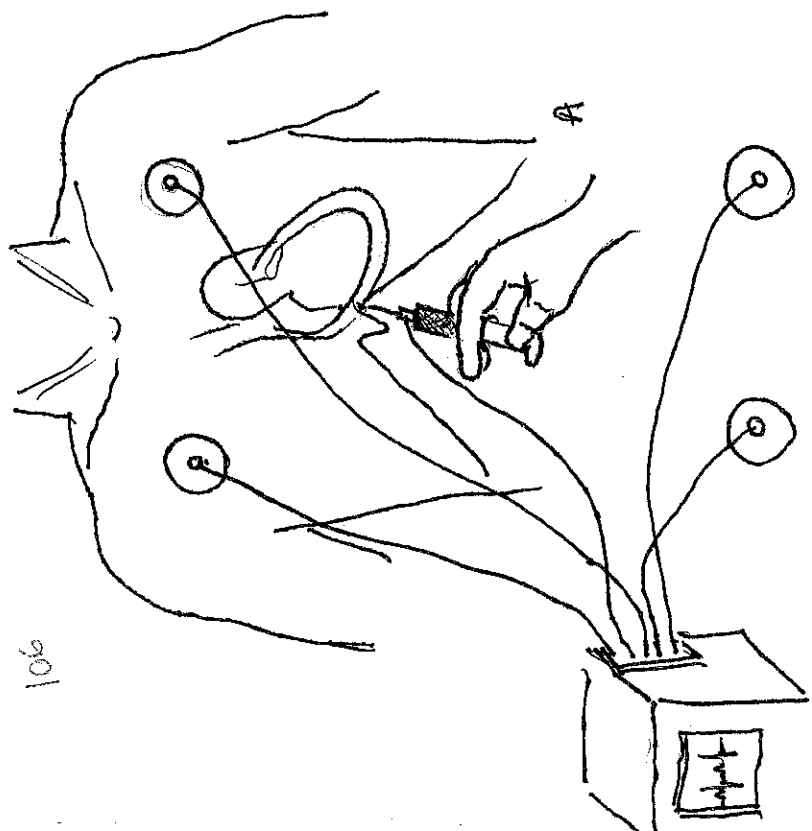
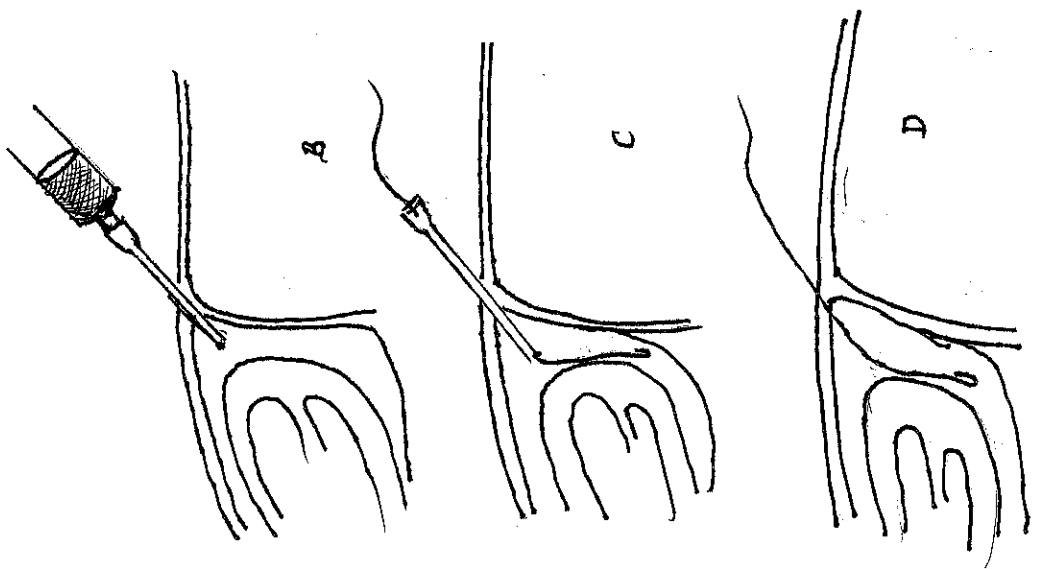
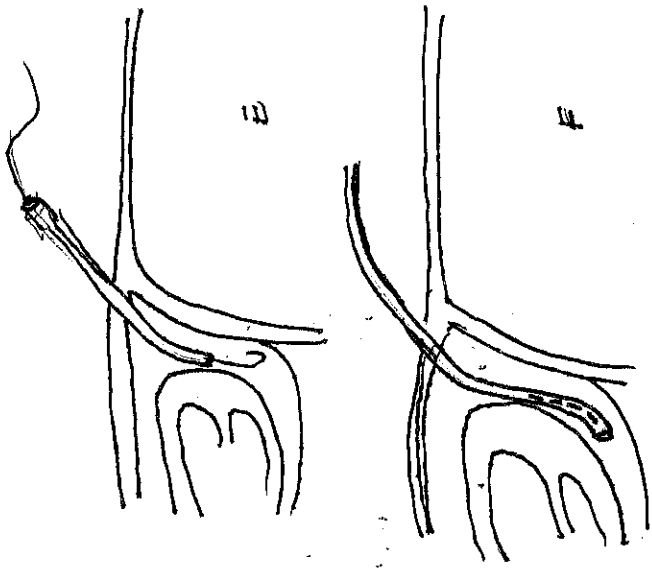

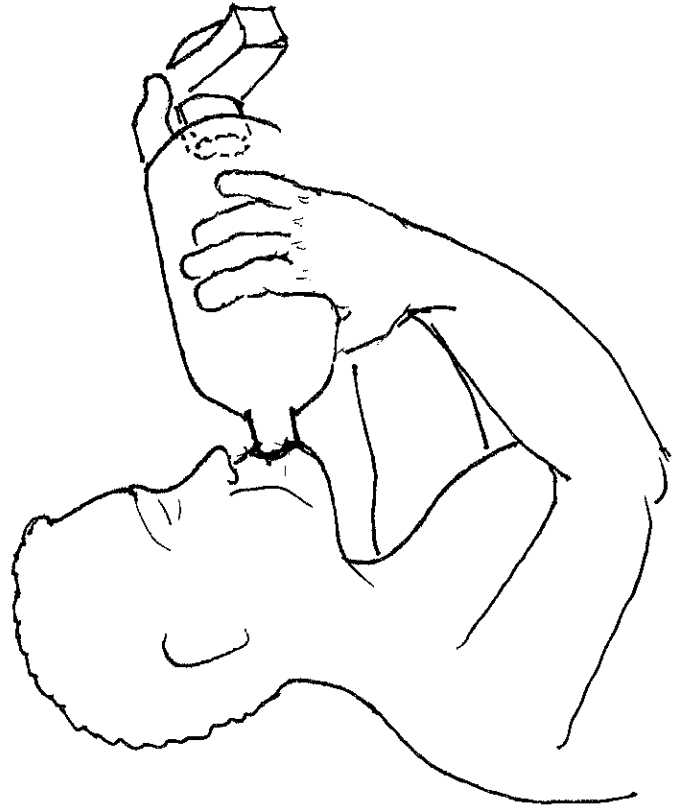

109

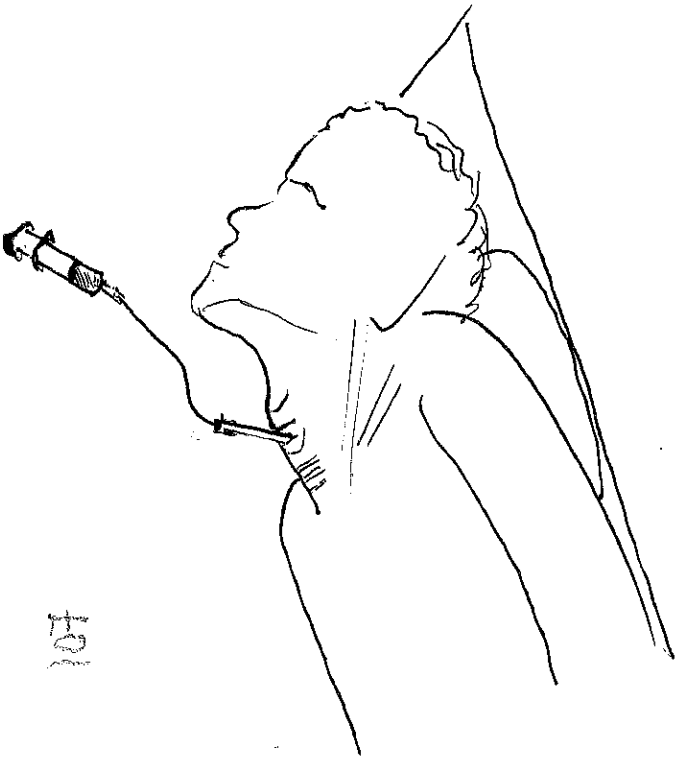

108

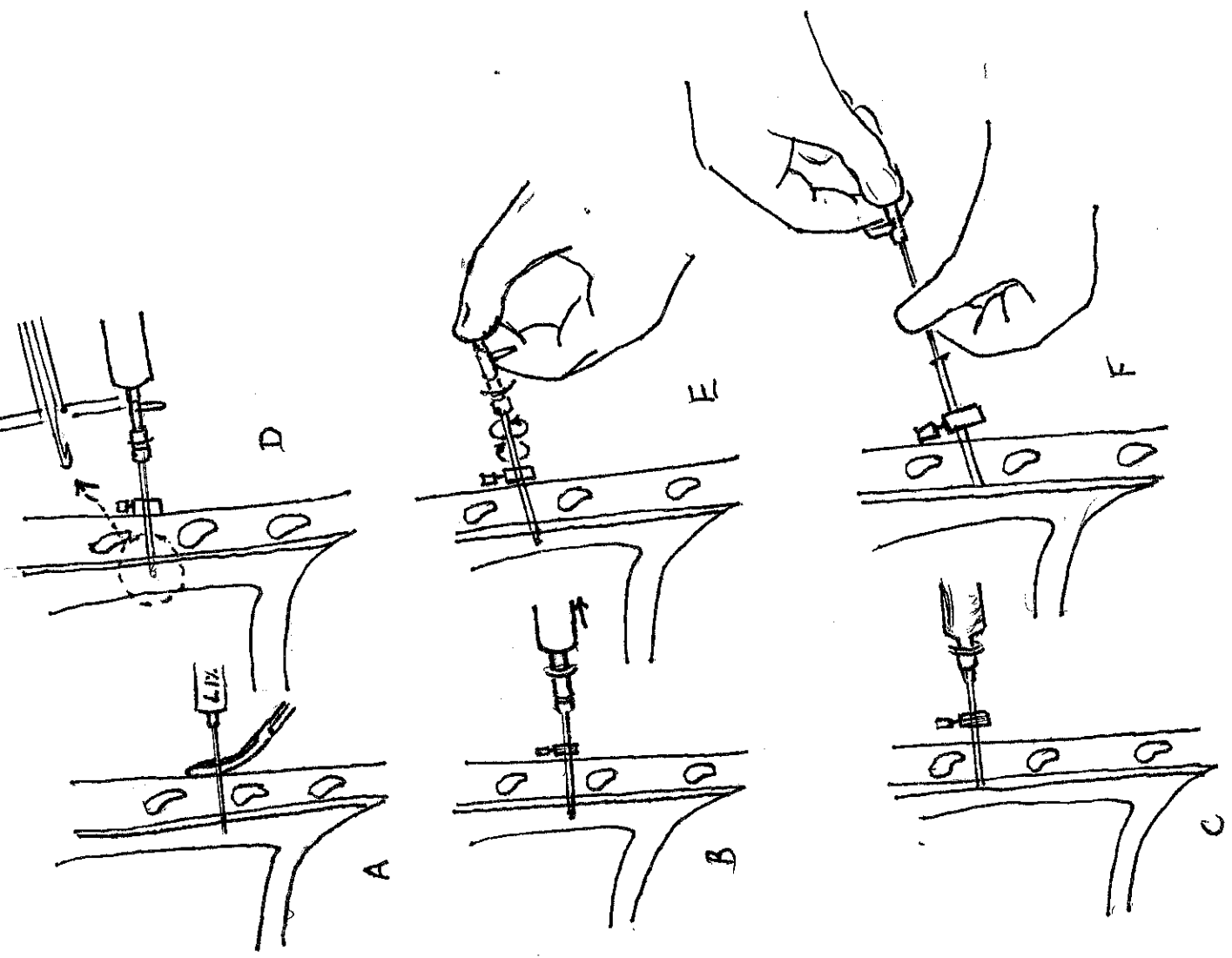

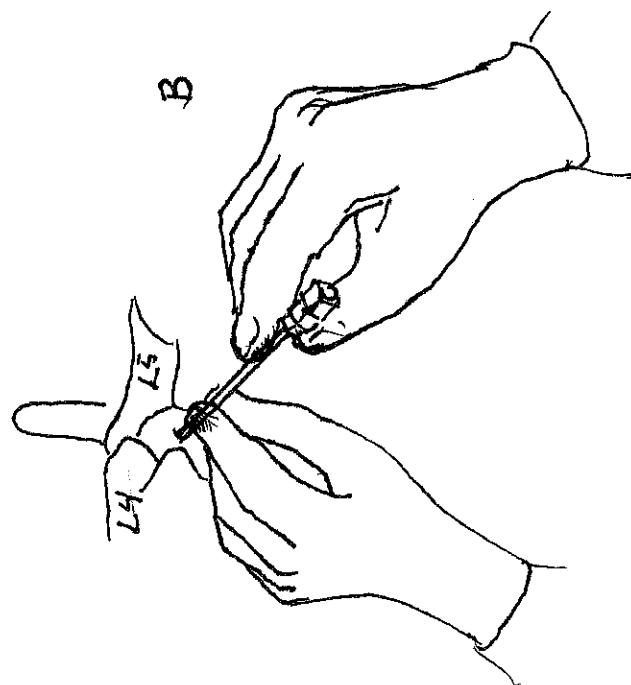
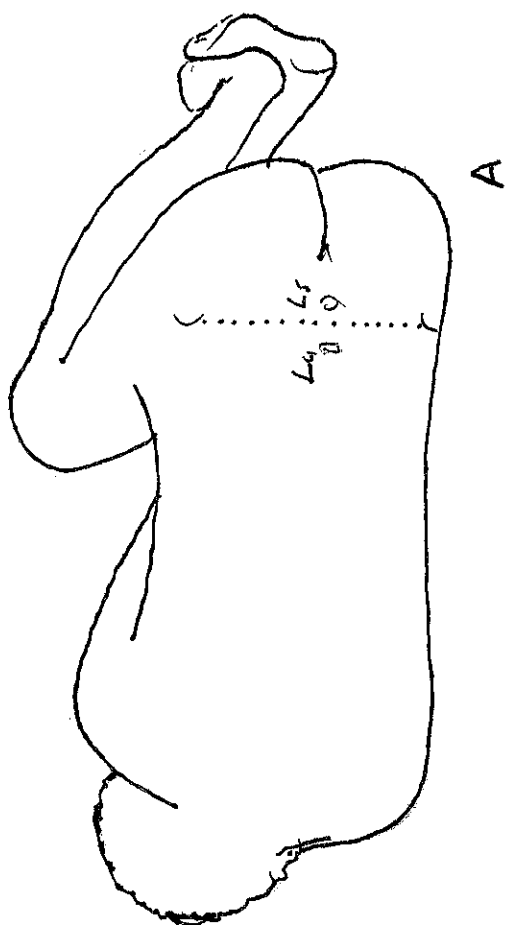
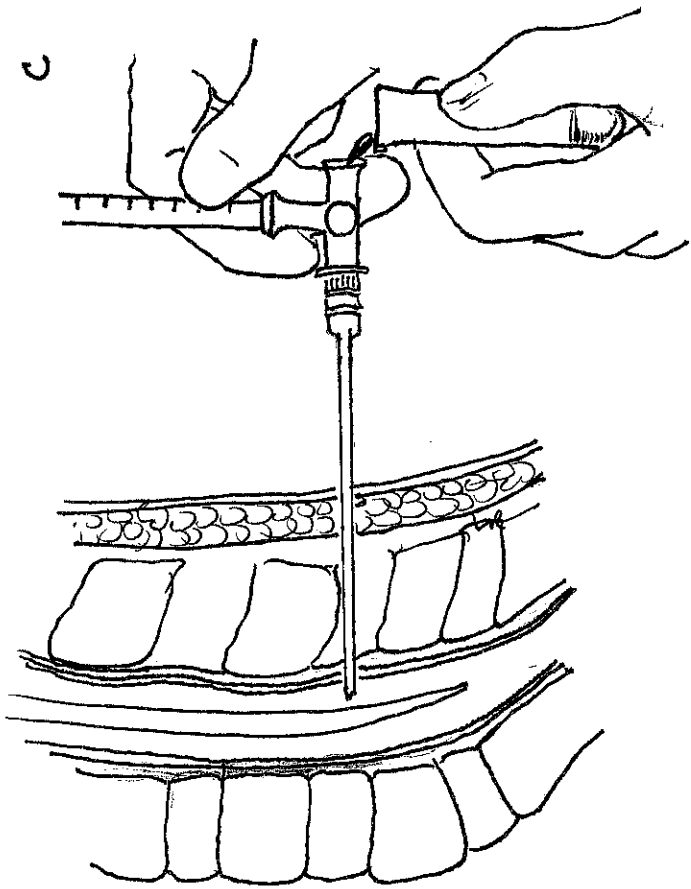

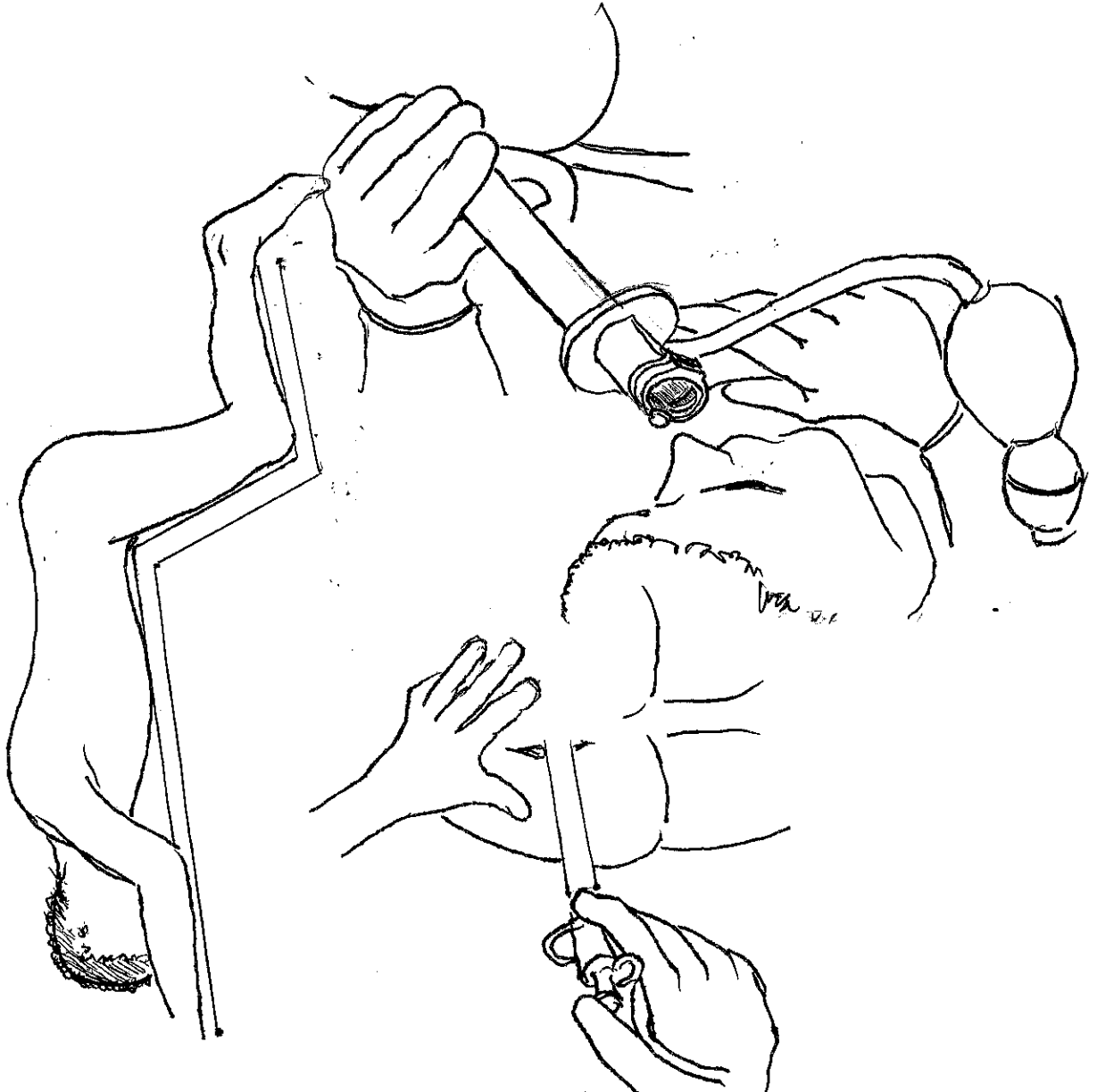



111

Diagram 111 illustrates a medical procedure. The main drawing shows a human torso with a hand holding a surgical instrument (E) near the abdomen. To the right, a hand holds a hand mirror (F) to inspect the back. Below the main drawing, a hand holds a syringe (G) and injects fluid into a rectangular block (H) containing a specimen.

113

Diagram 113 illustrates a medical procedure. The main drawing shows a hand holding a syringe (A) near the eye. To the right, a hand holds a hand mirror (B) to inspect the eye. Below the main drawing, a hand holds a syringe (C) and injects fluid into a rectangular block (D) containing a specimen.

115

Diagram 115 shows a surgical instrument with a long handle and a circular head, positioned over a circular area on a surface.

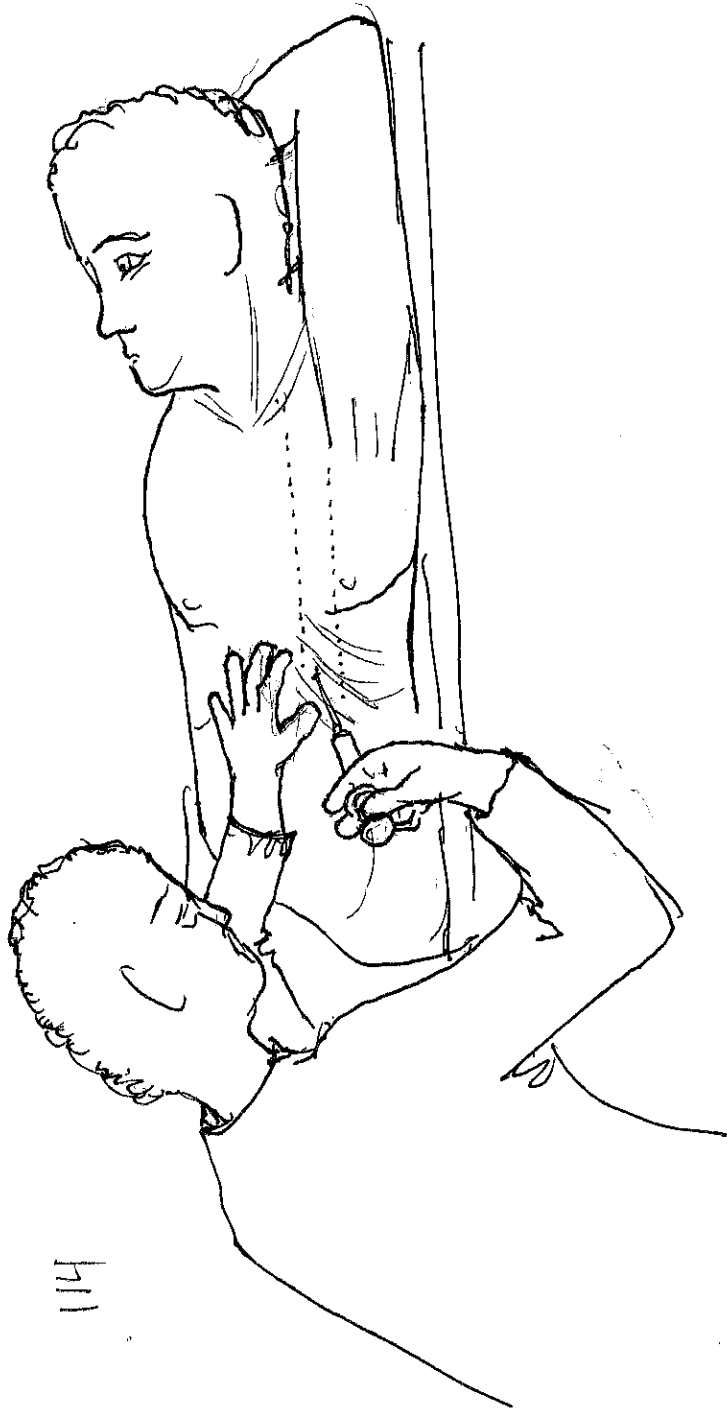

127

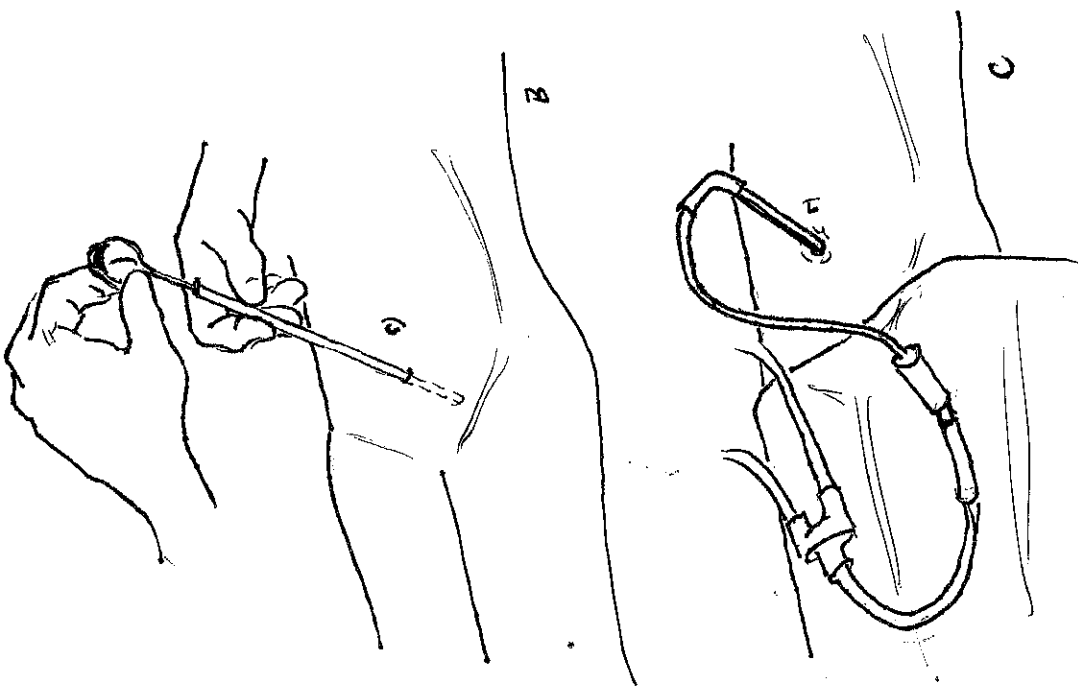
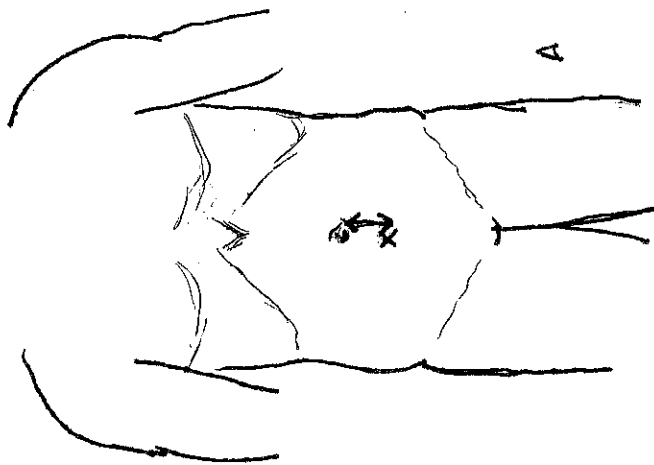

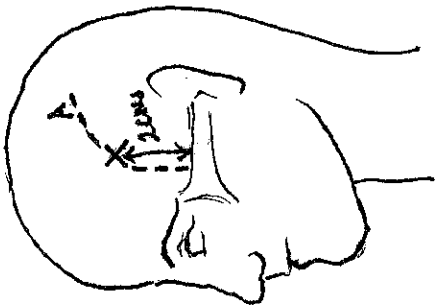

6-2

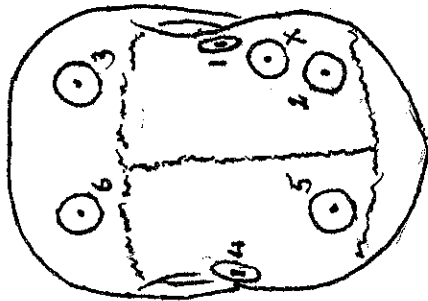

6-1

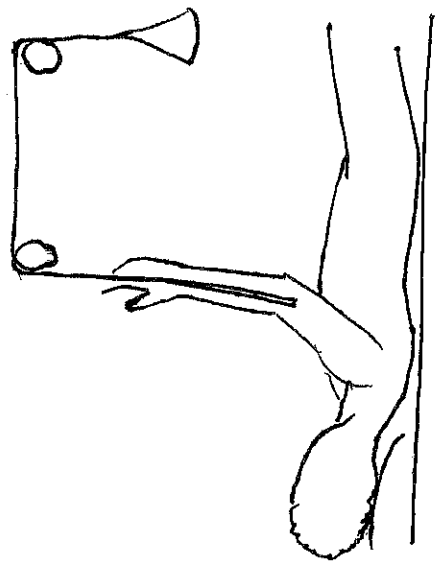

6.5

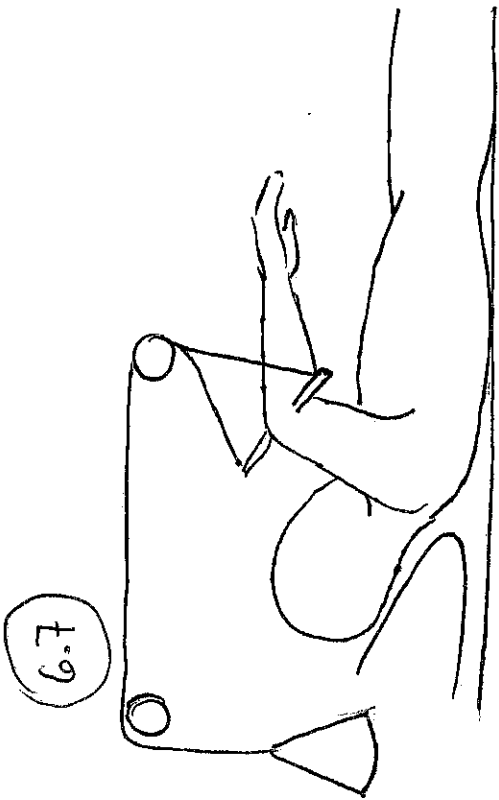

6.7

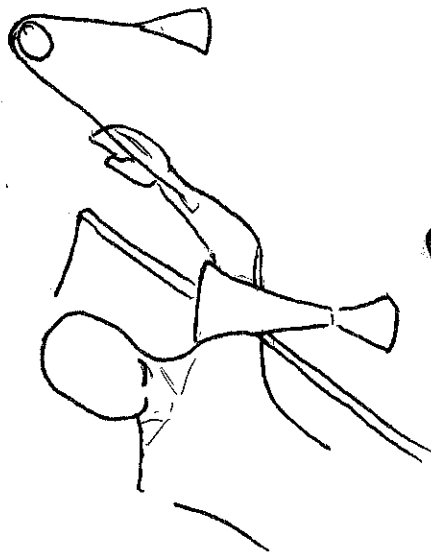

6.6

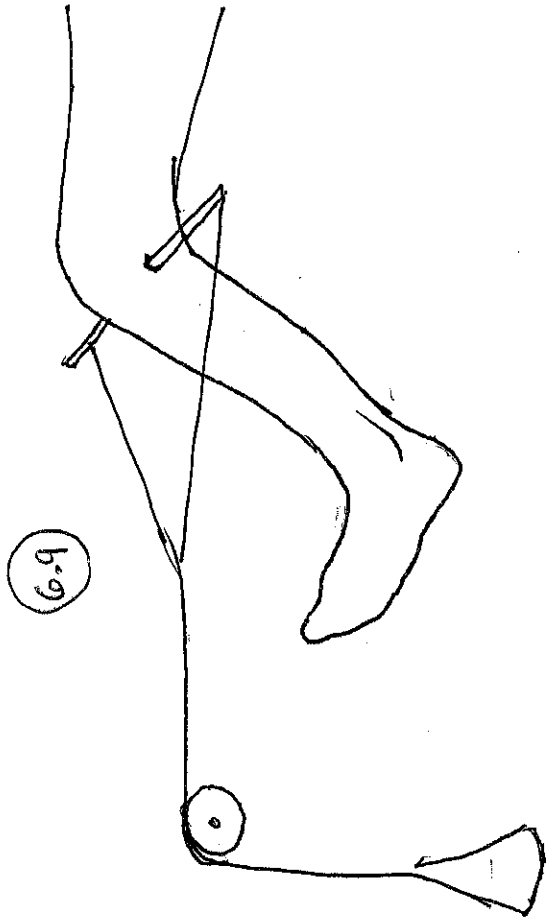

6.9

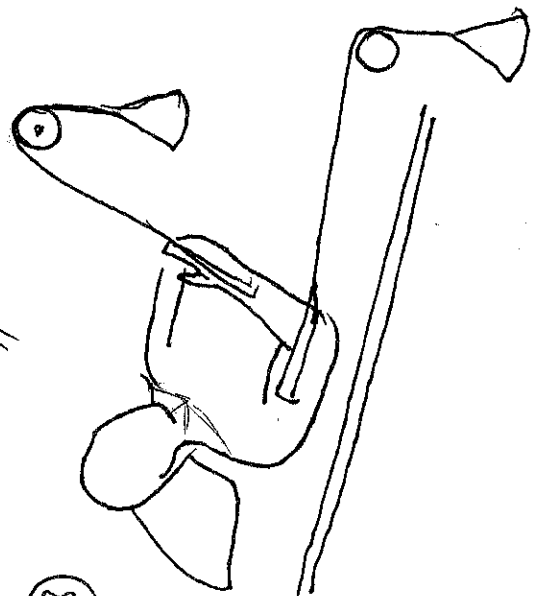

6.8

6.10

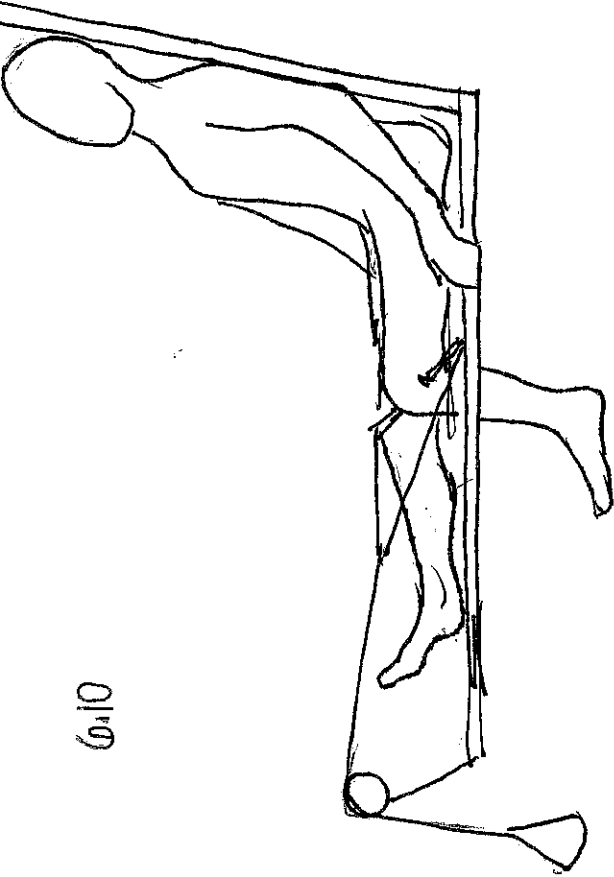

6.12

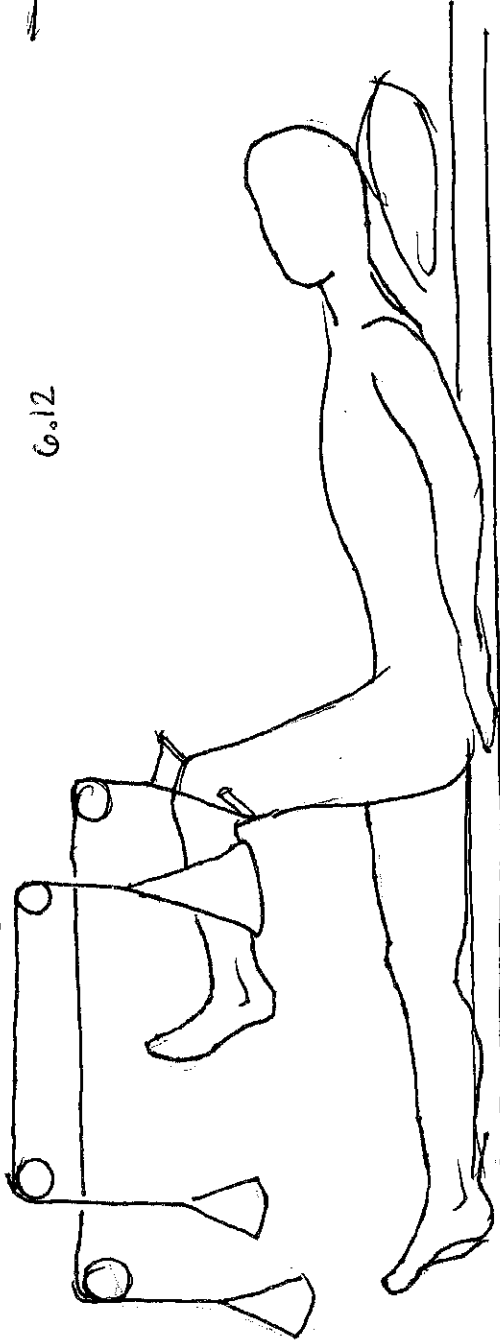

6.11

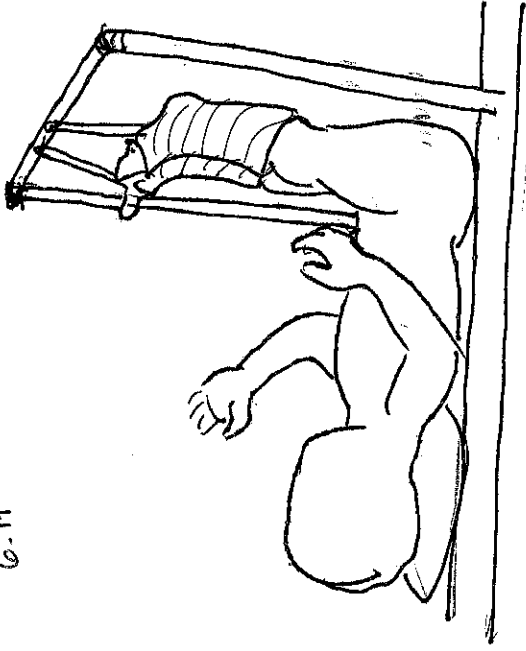

6.13

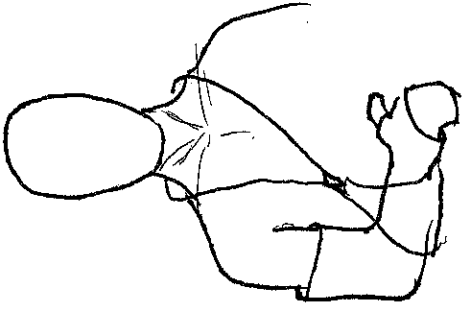
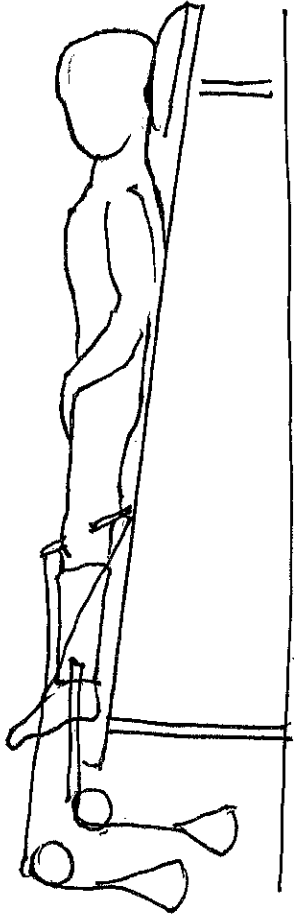

6.16

6.14

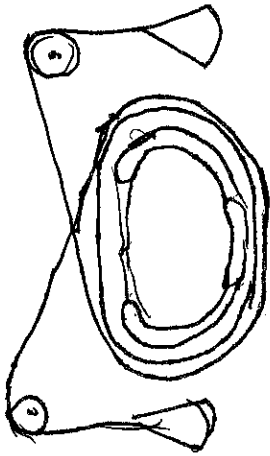

6.17

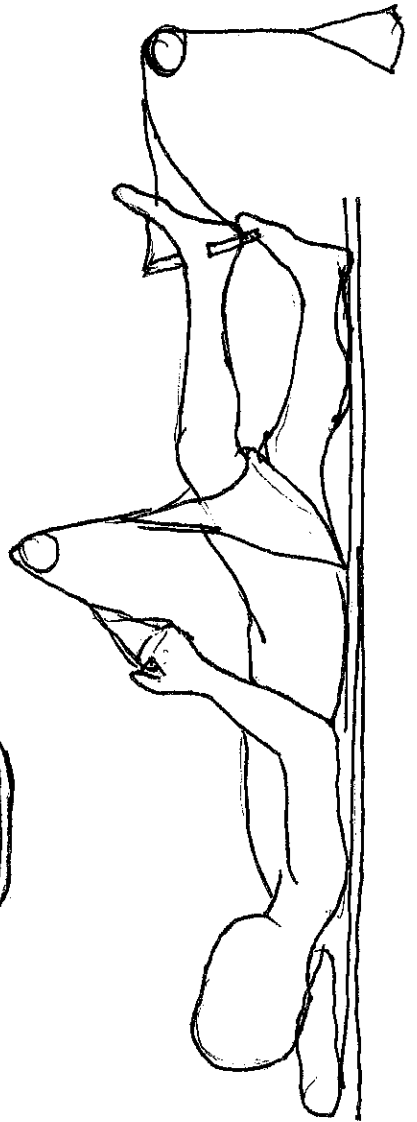
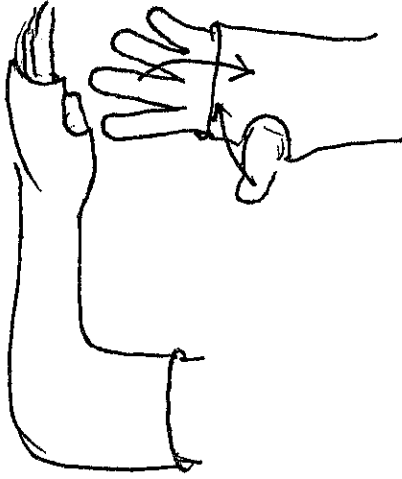

6.15

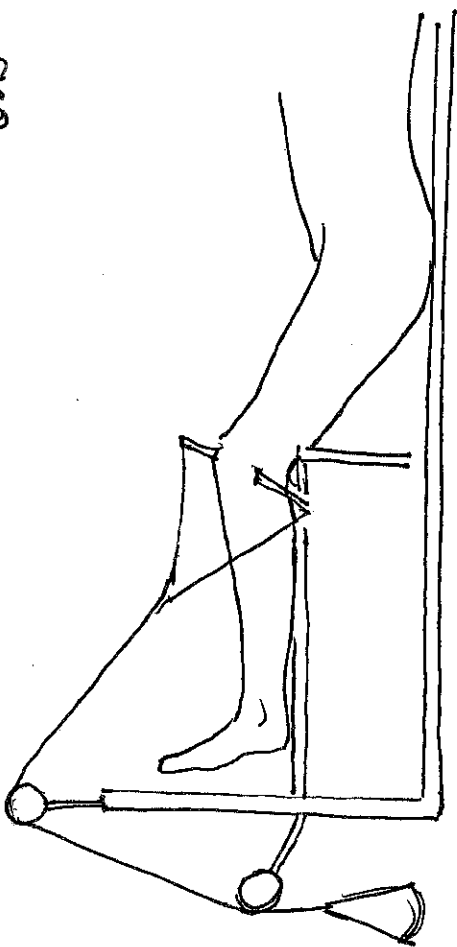



6.18

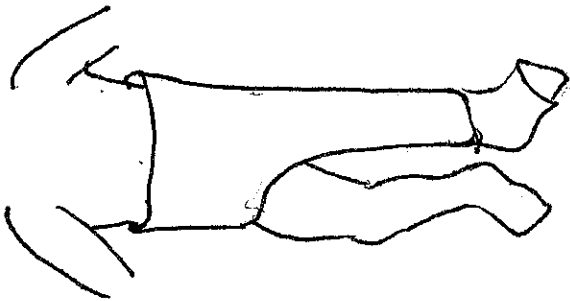

6.19



6.22

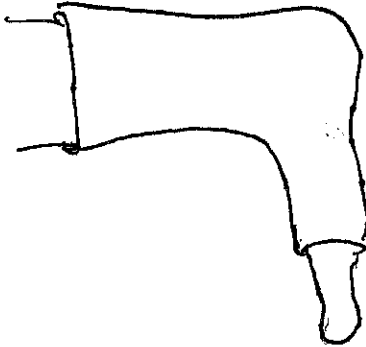

6.23

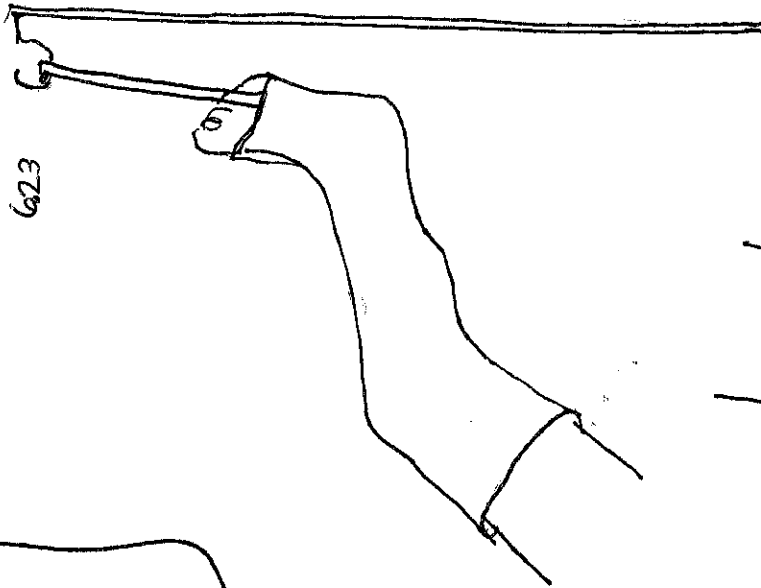

6.21

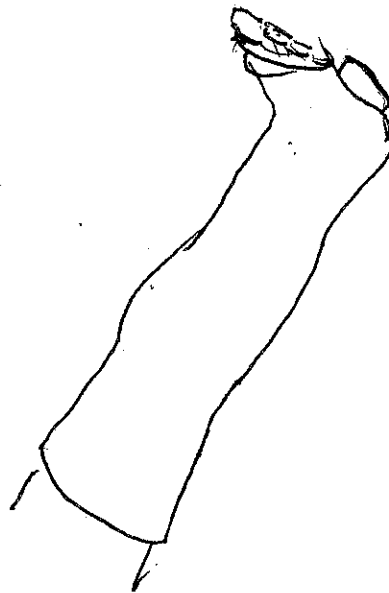

6.20

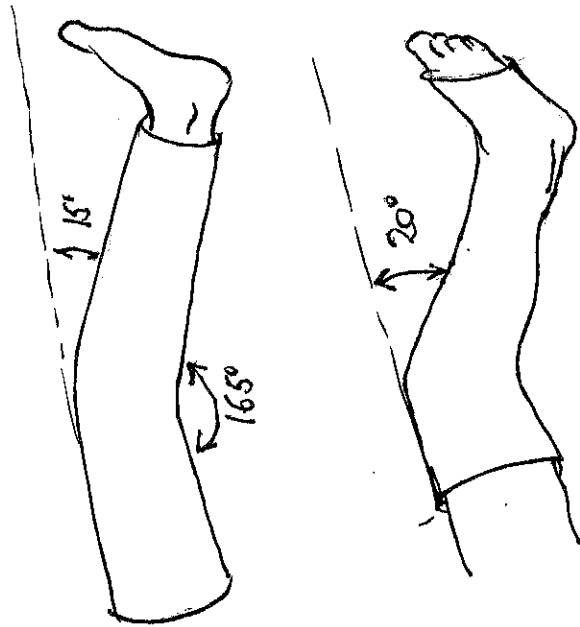

6.24

